





Only products identified as such are FSC™ certified



Our Facilities	4
Our Team	4
Core Values	6
Sustainability	6

EXTERNAL DOORSETS

Features & Benefits	8
Performance Characteristics	8
Doorset Options	10
Handing Information	11
Door Style Schedule	12
Classic Range Designs	14
Cottage Range Designs	18
Contemporary Range Designs	22
Communal Entrance Doorsets	26
Fire Rated Doorsets	27
Door Colour Options	28
Glass Options	29
Frame Options	30
Sills and Thresholds	31
External Door Hardware	32
External Door Hinges	33
Alternative Hardware Options	34
Numerals	35
Knockers & Bell Pushes	35
Cavity Closer System	36
Fixing Packs	36
Doorset Protection	37
Site Welcome Packs	37

INTERNAL DOOR IRONMONGERY

Internal Lever Furniture	38
Escutcheons & Turn/Release Sets	47
Hinges	48
Locks & Latches	50
Door Stops	52
Pulls, Knobs & Brackets	52
Hooks	52
Wardrobe & Bathroom Fittings	52
Bolts & Catches	53
Door Closing Devices	54
Mailboxes	55
Designer Bathroom Fittings	56
Gate Furniture	57

INTERNAL DOORS

K+ Internal Doors	59
Moulded Doors	60
Premium Moulded Doors	61
Feature Internal Doors	62
Veneered Internal Doors	64
Technical Details	64
Fire Rated Doorsets	65

ENVIRONMENTAL PRODUCTS

Rainwater Storage	67
Compost Bins	67
Laundry Products	68
Wildlife Habitats	68
Garden Buildings	70
Cycle Storage	71
Bat Roost	72
Swift Bricks	73

ASSOCIATED BUILDING PRODUCTS

Fire Rated Loft Doors	74
Access Panels	75
Standard Loft Doors	75
Loft Ladders	75
Ventilation Products	76
Sealants, Adhesives & Fillers	76

THE STORY SO FAR...	78
----------------------------	----



“

SUPPLYING QUALITY SINCE 1982

”

At Firth Doors & Hardware, we've been proudly providing doors and ironmongery to housebuilders since 1982. Over the decades, we've adapted to changing demands, regulations, and innovations-continually evolving our products and processes. Yet, despite our advanced facilities and modern technologies, we remain committed to delivering a personal, hands-on service.

- Our Field Sales Representatives are always available to meet our customers, whether at the office or on-site, ensuring responsive, face-to-face support whenever needed.
- Our dedicated Internal Sales Teams are always ready to assist, efficiently handling any queries with professionalism and expertise.
- Our qualified schedulers carefully prepare quotations from your drawings, ensuring the most suitable specification for each project.
- Our technical support team ensures all products meet the necessary certification and legislative requirements, giving you complete peace of mind.
- We keep our customers informed with regular updates on changes to regulations and standards that may impact our products or their projects.
- We offer bespoke design and product sourcing to meet the specific requirements of your project or design concept.
- Comprehensive after-sales care, including on-site training and toolbox talks, to support successful installation and ongoing use.
- We offer a reliable nationwide delivery service, primarily using our own fleet, supported by trusted third-party carriers to ensure timely and efficient deliveries.
- We warmly welcome customers to visit our premises in Dewsbury, West Yorkshire. Take a tour and make use of our newly refurbished meeting room facilities for a productive visit.





Sus·tain·abil·ity

NOUN

1. The ability to be maintained at a certain rate or level: "the sustainability of economic growth"
2. Avoidance of the depletion of natural resources in order to maintain an ecological balance:



AT UNIVERSITY I LEARNT A LOT ABOUT CARBON FOOTPRINTING, WHY IT IS IMPORTANT AND HOW TO CALCULATE IT BUT WE WERE NEVER GIVEN ANY OPPORTUNITY TO PUT IT INTO PRACTICE. DURING MY TIME AT IAN FIRTH DOORS & HARDWARE I HAVE BEEN ABLE TO TRANSFER THIS KNOWLEDGE AND HELP CALCULATE THE BUSINESSES SCOPE 1 AND 2 EMISSIONS. THE COMPANY HAS MADE SOME BIG STEPS FORWARD IN TERMS OF SUSTAINABILITY, UNDERSTANDING THE IMPORTANCE OF CALCULATING CARBON EMISSIONS AND SETTING TARGETS TO REDUCE CARBON OUTPUT. IN THE LONG TERM, THE BUSINESS SHOULD LOOK AT HOW THEY CAN MOVE TO A NET ZERO PRACTICE, ENSURING THAT THEY DO SO BOTH ECONOMICALLY AND SOCIALLY SUSTAINABLE. I HAVE THOROUGHLY ENJOYED MY TIME IN THE SUSTAINABILITY COORDINATOR ROLE AND THE EXPERIENCE HAS MADE ME DECIDE TO PURSUE A FUTURE CAREER IN SUSTAINABILITY.



Luke Dunnett

Leeds University placement student 2022

BUSINESS SUSTAINABILITY:

”The management and coordination of environmental, social and financial demands and concerns to ensure responsible, ethical and ongoing success.”

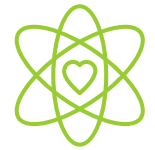

“Firth Doors & Hardware has a responsibility to minimise our impact on society and the natural environment when we procure, fabricate and distribute our Doors, Doorsets, Ironmongery and Associated Building Products.

We work closely with our employees, customers and suppliers with regards to sustainability and corporate social responsibility and engage in dialogue with our partners and those who are affected by our activities. We commit to working with all of our partners in a fair and ethical manner and commit to working in accordance with CIPS Code of Conduct & Ethics.

We strive to balance short and long term interests, and to make economic, environmental and social considerations integral to our decision-making.

We are committed to being a responsible business. This means conducting our activities according to rigorous ethical, professional and legal standards for which we have developed and implemented an Integrated Management System to satisfy the requirements of ISO 9001, ISO 14001, BSi Kitemark, FSC/PEFC and any relevant legal, regulatory requirements and approved codes of practice.”

SUSTAINABLE DEVELOPMENT GOALS

- 1. SOCIETY**
Adding value for customers, employees, business partners and the community.
- 2. ENVIRONMENT**
We recognise our responsibility to future generations.
- 3. ECONOMIC**
Creating economic value.

GO GREEN



10 GOOD REASONS TO BUY FIRTH COMPOSITE DOORSETS



- 1 PVC frame has steel reinforcement as standard to add rigidity
- 2 Adjustable hinges allow ease of installation and maintenance
- 3 Rubber perimeter seal in addition to two brush pile seals provides excellent weather performance
- 4 Glazing cassettes sealed externally with Stixall™ for improved watertightness
- 5 Stainless steel lever furniture included as standard
- 6 Letterplates available to suit a variety of performance and style requirements
- 7 Adjustable keeps allow for easy fitting and maintenance
- 8 Winkhaus Thunderbolt™ Multipoint Lock with tapered bolts fitted as standard
- 9 Huge range of door designs, glass patterns and colours available. Built as pre-hung doorsets
- 10 Wheelchair-friendly Slimline aluminium threshold system included as standard

Performance Characteristics

BS6375 General Performance Specification covering durability, basic security and weather tightness applies to all our external doorsets

PAS24 Enhanced Security Specification is available on a range of doorsets, approved by BSi Kitemark and Secured by Design, to meet the requirements of Building Regulations AD Part Q.*

FD30 Fire resistance is available on a range of doorsets, See page 27.

Our doorsets can be made to meet clear opening requirements and fitted with level access thresholds to meet the requirements of Building Regulations AD Part M.*

Doorsets can be made with acoustic properties to meet requirements of Building Regulations AD Part E.*

Glazing ranges available to meet Solar Gain (G-value) requirements of Part O*

Our doorsets have an Ozone Depletion Rating of zero and a Global Warming Potential of 5. We only use water based foam insulation within the construction of our doorsets.

All our doorsets have a U-value of 1.5w/m2K or better to meet the thermal performance requirements of Building Regulations AD Part L*

*Our doorsets can also meet the requirements of the Scottish Building Regulation Technical Handbook and Welsh Building regulations.





FROM DRAWING TO REALITY

With all doorsets made-to-order we can produce most configurations from single open-in to double winglight frames, from fanlights to open-out communal entrance doorsets, the possibilities are almost limitless. Simply send the details of what you are looking for to our estimators and we can take your design concepts to the finished street scene.

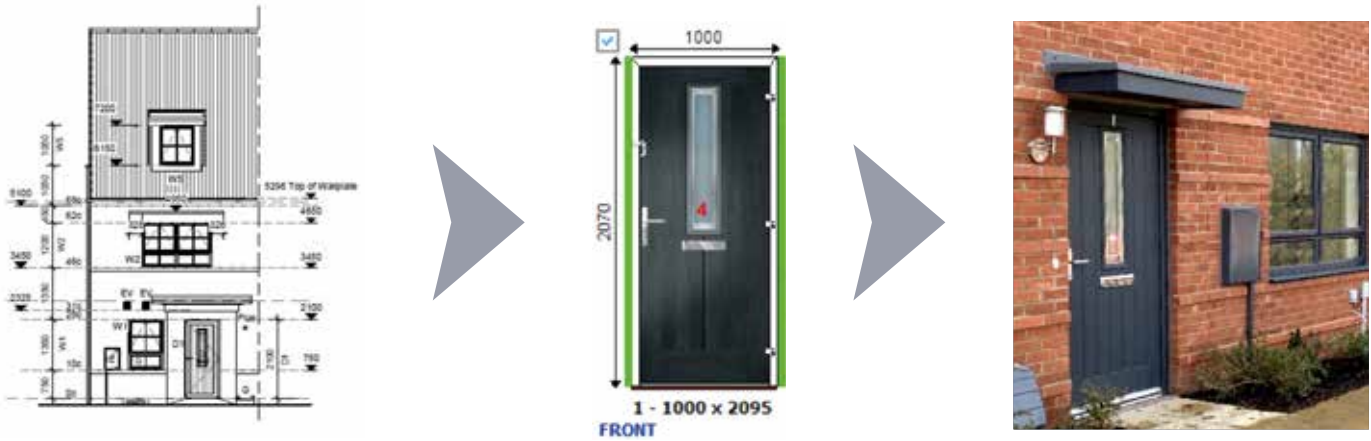

FROM DRAWINGS > THROUGH OUR DOORSET DESIGN SOFTWARE > TO DELIVERY



SINGLE GRP GLAZED PANEL SIDELIGHT FRONT RESIDENTIAL DOORSET

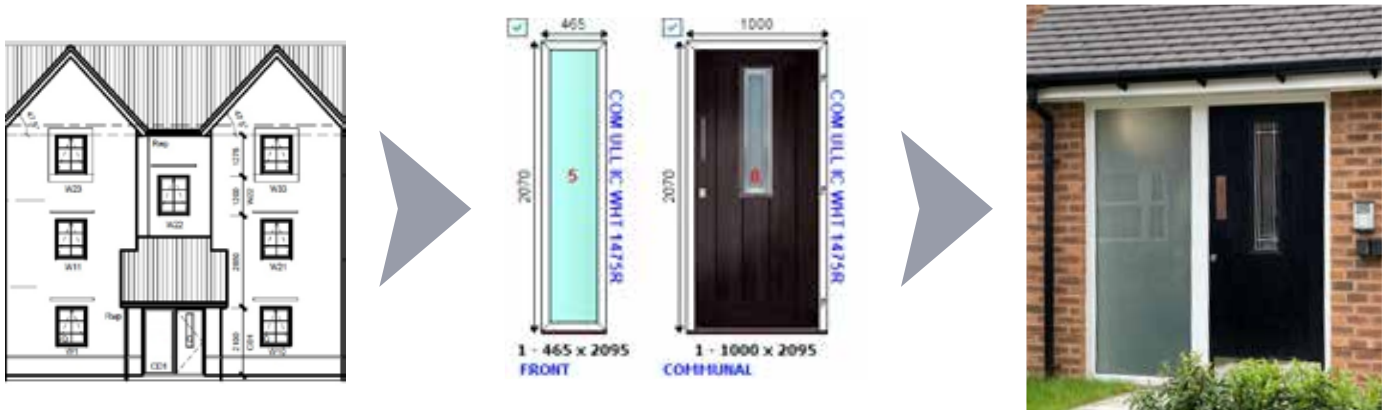

SINGLE DIRECT GLAZED SIDELIGHT COMMUNAL ENTRANCE DOORSET

EXPLORE THE POSSIBILITIES

Single Doors, Single sided sidelights, Double sided sidelights, Winglights, Fanlights, Double Doors, Front Doors, Rear Doors, Garage Personnel Doors, Bin Store Doors, Communal Entrances, Open-In or Open-Out, with every door bespoke to your needs there is no need to compromise on design.



HANDING INFORMATION

When viewed from the outside.

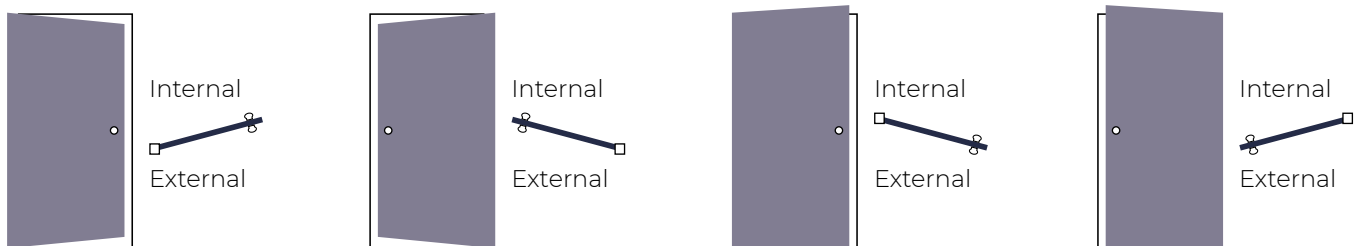

LHH Left Hand Hinged Open In

RHH Right Hand Hinged Open In

LHH Left Hand Hinged Open Out

RHH Right Hand Hinged Open Out



CLASSIC RANGE



IFU.01
Huron

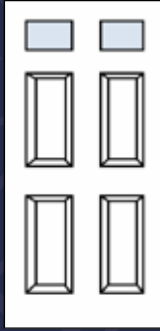

IFU.02
Erie



IFU.26
Clearwater

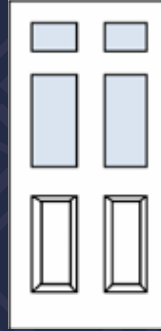

IFU.48
Balaton

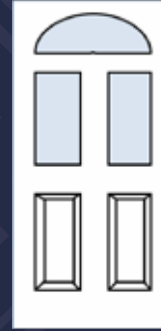

IFV.40
Alto

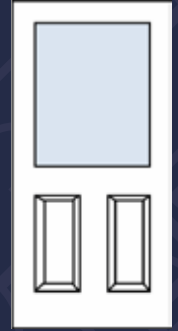

IFU.05
Michigan



IFU.30
Placid

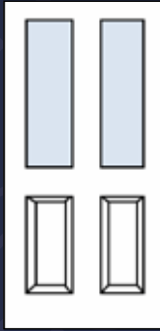

IFU.07
Ontario

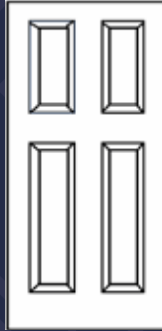

IFU.29
Tahoe

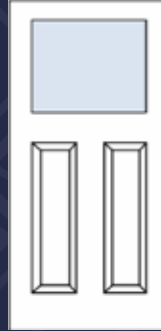

IFV.80
Mask

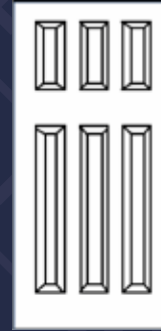

IFU.63
Lutyens
unglazed

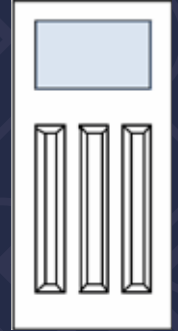

IFU.64
Lutyens



CONTEMPORARY RANGE

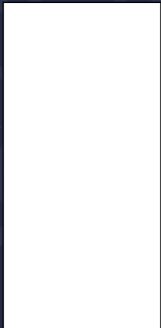

IFU.49
Flush

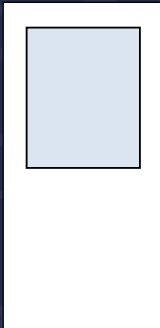

IFV.55
Katrine

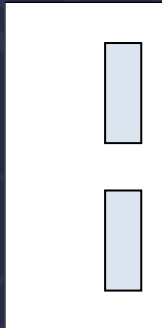

IFU.56
Ryan

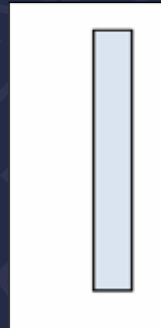

IFU.59
Powell

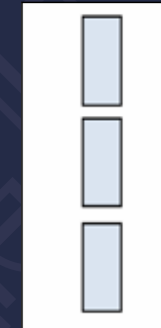

IFU.69
Charlotte

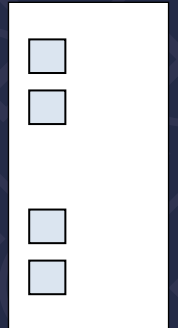

IFU.82
Avon



COTTAGE RANGE

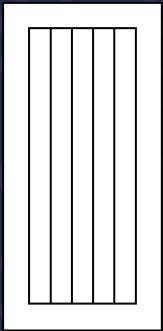

IFU.28
Cottage

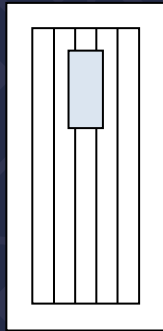

IFU.27
Superior

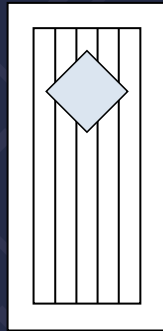

IFU.37
Coniston

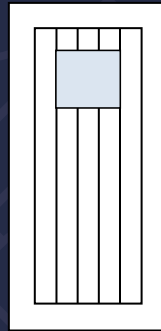

IFU.38
Windermere

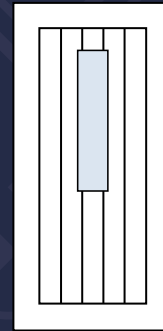

IFV.57
Ullswater

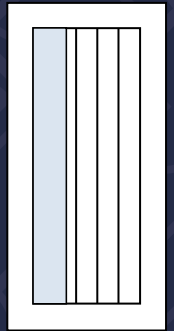

IFU.80
Flaxby

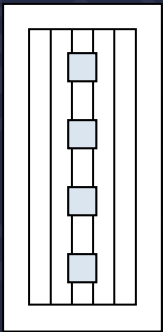

IFV.71
Cottage Aire

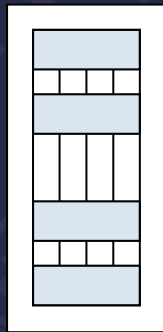

IFV.39
Grasmere

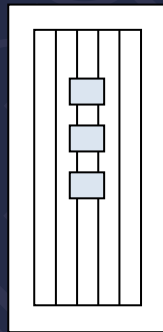

IFV.70
Beck

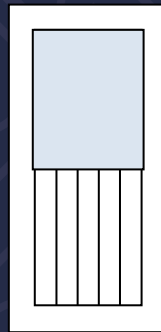

IFV.78
Thirlmere

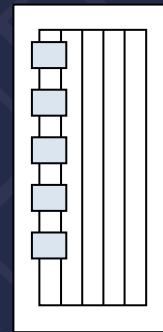

IFV.79
Conn

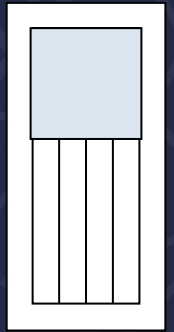

IFV.64
Owel



IFU.11S
SuperNova

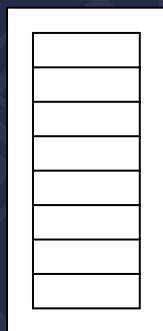

IFU.31
Modena

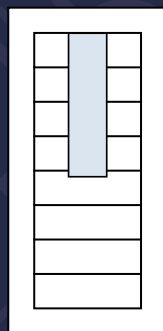

IFU.24
Mardyke

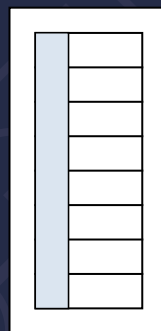

IFU.83
Fewston

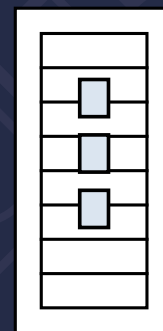

IFU.19
Hawes

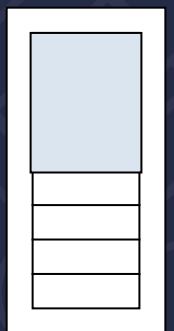

IFU.12
Cray

These are just a selection of door designs that are possible. If you cannot see the design you are looking for please send details to us and we will do our best to accommodate your specific requirements.



A timeless range of door styles with a variety of glass designs from plain clear or obscure glass through contemporary geometric styles, to very decorative traditional effects.



Huron



Erie
with Clear Imperial
Chrome Bar Glass



Michigan
with Cube Glass



Ontario
with Cotswold
Obscure Glass



Ontario
with Imperial Chrome Bar Glass



Placid





Whether it is a Front Entrance Doorset, Rear or Garage Personnel, these designs give plenty of options to compliment any elevation.



Lutyens 6 panel
with Cube Glass



Clearwater
with Simplicity Glass



Alto
with Viola Blue Glass



Michigan
with Clear Glass



Mask
with Satin White
Integral Bars Glass



Balaton
with Cube Glass

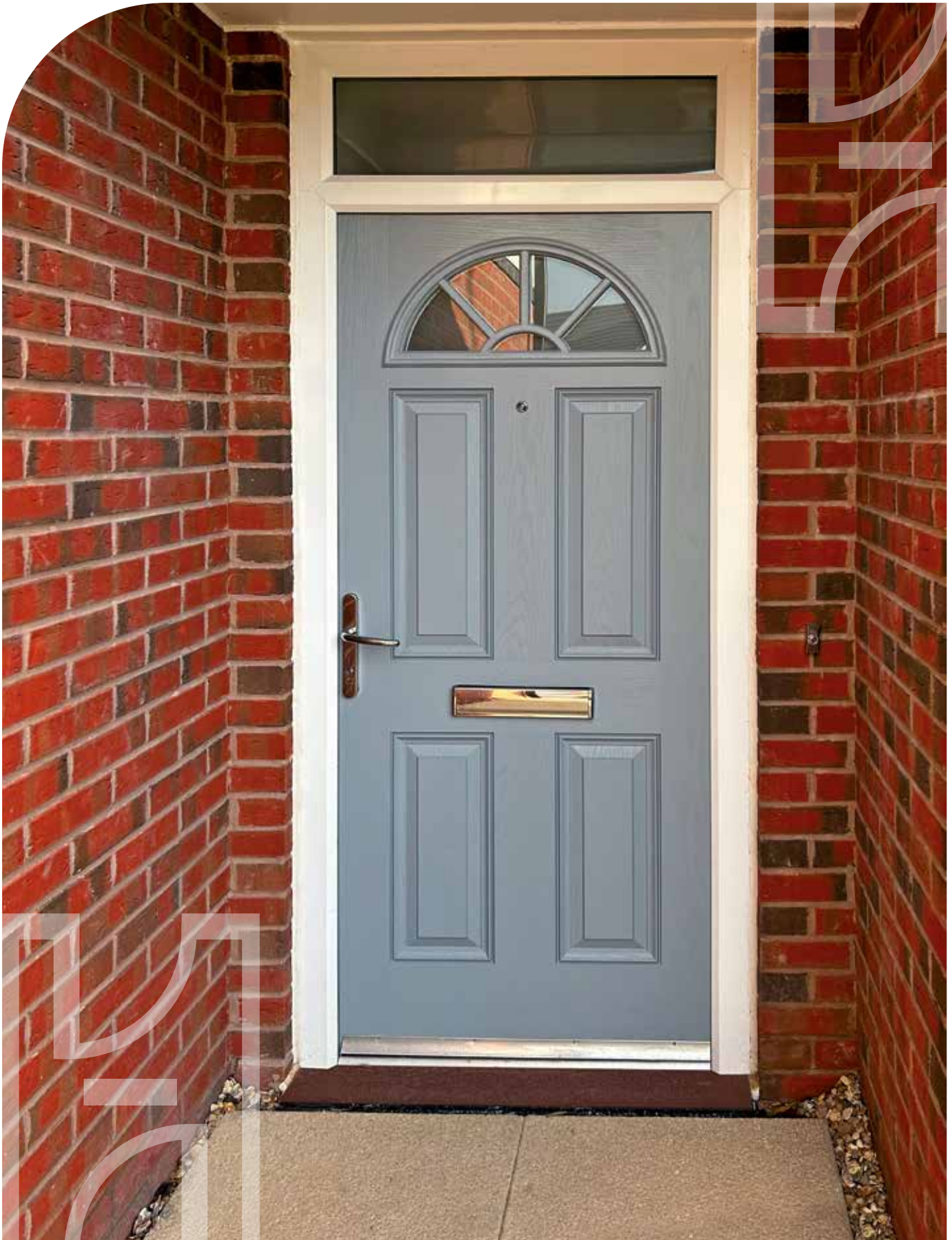



The Cottage door is the pinnacle of versatility enabling endless possibilities in design.



Cottage



Superior
with Monarch Diamond Glass



Coniston
with Stippolyte Glass



Flaxby
with Cotswold Glass



Grasmere
with Satin Glass



Beck
with Cube Glass





Don't be deceived into thinking Cottage means old fashioned when there are so many modern looking designs that can be made using this door style to suit many design applications.



Ullswater
with Imperial Chrome
Bar Glass



Emma
with Cube Glass



Windermere
with Twist Glass



Conn
with Satin Glass



Owel
with Cotswold Georgian Bar Glass



Thirlmere
with Stippolyte Glass





Let your imagination run riot using the Flush door as your blank canvas to create infinite design possibilities.



Flush



Ryan
with Cotswold Glass



Powell
with Cube Glass



Super Nova
with Satin Glass



Volta
with Simplicity Glass

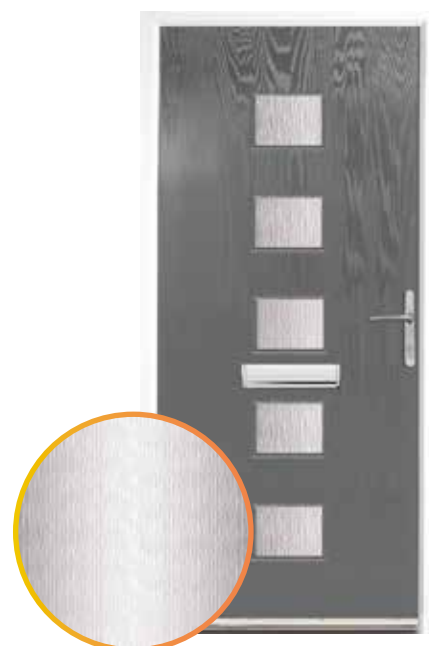

Lyon
with Cotswold Glass





New Modena door design gives more scope for creating the perfect look that is right on trend.



Modena



Fewston
with Satin Glass



Mardyke
with Cube Glass



Mardyke
with Imperial Chrome Bar



Hawes
with Cotswold Glass



Cray
with Clear Glass



COMMUNAL ENTRANCE DOORSETS

Any style of door and any design of frame can be made into a doorset for use as the communal entrance doorset to a block of apartments.

A range of hardware specifications is available depending on the opening orientation, access control and security level requirements needed for the project.

A choice of stainless steel pull handles and escutcheons can be chosen from our extensive range. Matching push plates and kick plates are recommended to protect these doorsets from extra wear from the higher volume of users.



Incorporating the AV4 Autofire Locking system with a motor, this configuration of doorset is ideal for the communal door of any multi-occupancy dwelling. Once wired into an access control system the householder has the ability to open the communal door remotely, whilst the door maintains its mechanical functionality and security at all times.

Automatic locking prevents casual entry in communal areas.



Our communal doorsets include cable and power supply, ready to be connected to mains and to any configuration of access control system. Ask for details of such systems which we can provide, including intercom systems, card/fob entry as well as new Smart devices.

NB Mains connection of the doorset plus any access control system must be undertaken by qualified electrical engineers in accordance with Building Regulations.



CHECK OUT
OUR RANGE
OF POSTAL
BOXES

FIRE RATED APARTMENT ENTRANCE DOORSET

Tested in UK BS476-22:1987 our FD30 Apartment Entrance doorsets simply do the job



Supplied with overhead doorcloser to comply with fire regulations

Softwood frame with intumescent fire strip and separate AQ21 weather / draught strip to provide a continuous smoke seal. Fully tested to BS476-31.1.1983 for smoke control.

Stainless Steel Ball Bearing hinges to EN1935 Grade 13

Incorporating AV2 Autofire Multi-Point Lock with TS007 3* cylinder / Lever solution this doorset offers security as well as giving 30 minutes fire integrity.



Overhead Doorcloser



Intumescent Fire Protection



Threshold Strip



Fire Resistance and Smoke Control Testing

EXTERNAL DOOR COLOUR OPTIONS

The GRP door leaf is available in a range of colours to suit any design scheme. Classic colours and some contemporary colours are kept in stock, but any colour can be bought to order.

NB The external face only of the door leaf is finished, the door edges and internal face would be White RAL9016

CLASSIC COLOURS



White
RAL 9016



Black
RAL 9005

CONTEMPORARY COLOURS



Anthracite Grey
RAL 7016



Slate Grey
RAL 7015



Pale Green
RAL 6021

SPECIAL COLOURS

Any RAL or BS colour can normally be bought to order* Here are a few examples of on-trend colours.



Light Ivory
RAL 1015



Pebble Grey
RAL 7032



Agate Grey
RAL 7038



Silver Grey
RAL 7001



Stone Grey
RAL 7030

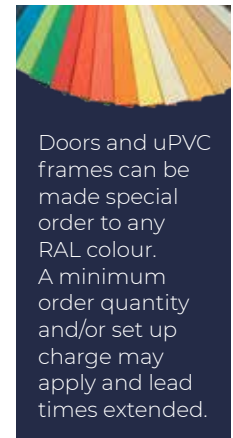

Wine Red
RAL 3005



RED
NCS53560-Y90R



Lemon Yellow
RAL 1012



Reed Green
RAL6013



Green
RAL6009



Blue
RAL5004

*Extended leadtime, a minimum order quantity and or set up charge may apply

CLASSIC GLASS PATTERNS



CLEAR
Privacy Level 0



WARWICK
Privacy Level 1



MINSTER
Privacy Level 2



AUTUMN
Privacy Level 3



STIPPOLYTE
Privacy Level 4



COTSWOLD
Privacy Level 5



SATIN Also known as Acid Etched
Privacy Level 5



Also available with integral bars, white as standard, other colours on special order.

All above can be used in any door design, fanlight and sidelight frames.

DECORATIVE GLASS PATTERNS From traditional styles to sleek contemporary designs, we offer a wide range of options to suit.



CUBE
Ultra modern, this simple yet effective design of satin centre with a clear boarder is perfect for any contemporary style doorset. And we can make sidelights match too!



CHROME BAR
Clear glass with integral chrome bar cross works well to maximise light but add a touch of elegance. Perfect for our Erie door style to maintain privacy.



SIMPLICITY
Available in clear or Satin backing this graceful design adds a touch of class. Works well with Erie, Balaton, and Clearwater classic door styles.



MONARCH DIAMOND
Ice effect obscure glass with clear bevel and silver leadwork is just sumptuous. Suits Superior and Coniston door styles best.



VIOLA
Want to add a pop of colour in the glass? Then Viola offers that versatility – Red, Blue, Green or leave clear. Available with clear or Minster backing you decide on the privacy level. Suits Michigan, Ontario, Balaton, Erie, Clearwater, Alto classic door styles well.



IMPERIAL CHROME BAR
A perfect blend of elegance and modernity this range of glass is a proven timeless favourite. Integral chrome bars can be seen through the clear lines that boarder the satin opaque areas. The larger size for Michigan is available 1 pane, 4 pane or 9 pane, whereas The smaller 1 pane looks great on Ontario and fabulous on Ullswater.

CAN'T SEE THE PERFECT GLASS DESIGN FOR YOU? THEN CALL US TO DISCUSS BESPOKE OPTIONS.

All glass units in doors and frames are double glazed CE marked to EN1279, include toughened glass to EN12150 and 6.8mm Class P1A laminated glass to EN14449. Enhanced thermal performance glass is available on most styles – ask for more details.

EXTERNAL DOOR FRAME DESIGN OPTIONS

External Doorframes can be made in many different shapes and sizes to suit a range of design briefs. Door slab sizes are 838 or 914mm wide by 2013mm high and frames are built to suit slab and structural opening.

- Single Frames
- Fanlight Frames, with or without bars or beading in the glass
- Arched Fanlight Frames
- Single Sidelight Frames, with or without midrails
- Double Sidelight Frames, with or without midrails
- Single or Double Sidelight Frames to take Sidelight Panels
- Winglight frames, Single or Double
- Sidelight / Fanlight Combination Frames
- Double Door Frames

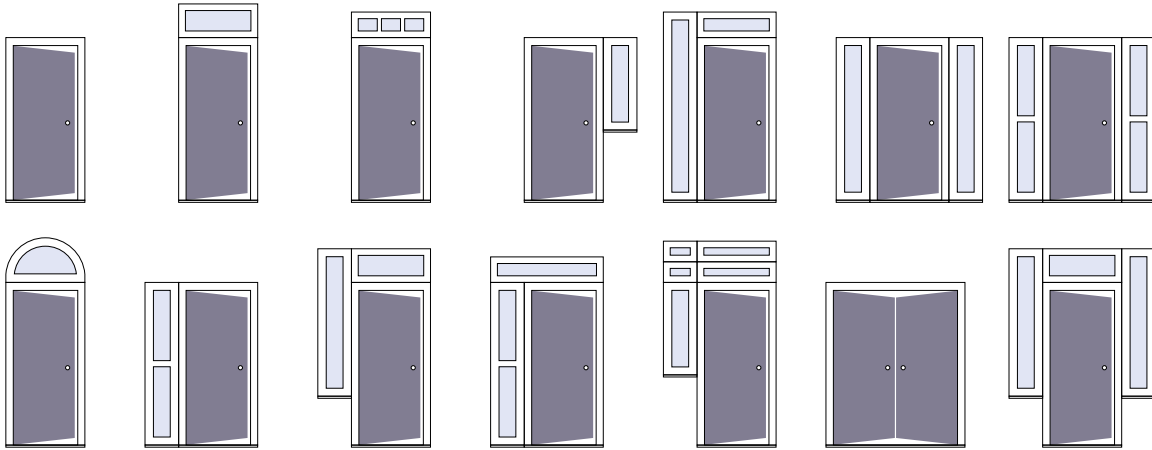

Whether Open in or Open out and to suit LHH or RHH we can accommodate your requirements in either PVC or primed softwood.

FRAME MATERIAL OPTIONS

PVC PROFILE

- 2x brush & 1x rubber seals pre-fitted
- Steel reinforced
- Prefinished PVC needs no ongoing maintenance other than cleaning.
- White smooth base
- Available pre-finished foiled and sprayed
- Made from 70% recycled materials
- Fully welded joints
- Can be recycled up to 10 times
- Overlaps door more than softwood.
- Available in 40mm and 55mm profile widths
- Add-ons available from 10mm to 50mm to accommodate varied openings



SOFTWOOD PROFILE

- 1x rubber seals pre-fitted
- Solid natural softwood, may include knots and some natural grain
- Supplied primed for onsite painting and therefore ongoing routine re-painting
- Finger jointed, screwed and glued joints
- Softwood sourced from FSC/PEFC managed forests
- Available in 39mm profile widths



PRE-FINISHED FOILED PVC FRAME COLOUR OPTIONS:

-  Slate Grey Woodgrain
-  Anthracite Grey Woodgrain
-  Black Ash
-  Cream White Woodgrain
-  Agate Grey
-  Chartwell Green

Other foiled colours may be available depending on volumes, as well as sprayed smooth special colours. See T&Cs on page 28





PVC

- Available in white or finishes to match frame profile
- 150x30mm
- 180x30mm
- 85mm stub sill also available
- Matching sill end caps supplied with frame



HARDWOOD

- Special Order with commonly requested sizes:
- 125x25mm
- 175x25mm
- 230x25mm
- 220x45mm
- Supplied unfinished



COMPOSITE

- Includes rear lip to improve weathertightness
- 170x25mm
- 190x25mm
- Prefinished composite material
- Highly durable, guaranteed not to warp, shrink or distort
- Mahogany effect finish
- Subject to sufficient volume, composite sills can be supplied in black or grey.



3-PART COMPOSITE

- Prefinished composite material
 - 70x25mm mid section with rear lip
 - External clip-in ramps available at 102mm and 135mm
 - Ramps supplied separate for fitting at suitable build stage to reduce risk of on-site damage
 - Internal clip-in 75mm transition ramp optional extra
- Protection items available – see Page 37

ALUMINIUM AM3-70 & AM3

- o Fits to underside of frame legs
- o No need for additional threshold
- o AM3-70 requires front ramp
- o Rain deflector sold separately

External ramps available from 49mm to 145mm
Internal ramps available 15mm and 49mm

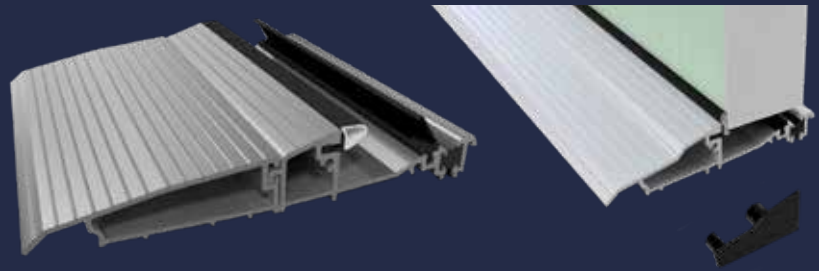

THRESHOLDS

Frames with PVC, Hardwood or Composite Sills will require a threshold system fit between frame legs to provide weathertightness.

All thresholds have been tested with our doorsets under BS6375.

A combination of sill, threshold and transition ramp will generally meet the requirements of Part M where the external path/drain cover meets the front ramp flush with no upstand.

SLIMLINE MILLED

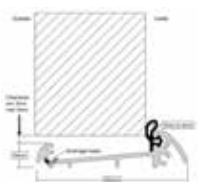

Slimline threshold kit - includes rain detector



Slimline threshold is aluminium and sits on top of the composite sill section.
Slimline threshold kit includes rain deflector with end caps. The threshold has two rubber strips. One front, one in middle.
Composite Sill

AM3-70 MILLED

Open-out versions are also available

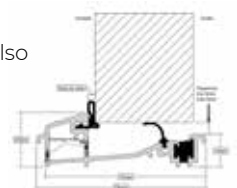

RAIN DEFLECTORS



- Aluminium face fixed in finish to match threshold.
- Comes as standard with Slimline Threshold



- PVC colour matched to door available as special order
- Clips onto aluminium channel and comes with matching end caps

INTERNAL TRANSITION RAMP

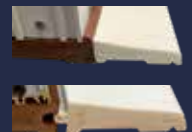

Available in Aluminium or Composite Clip-in White.
Non clip-in version available as special order

EXTERNAL DOOR HARDWARE

STANDARD FRONT



- PAS24:2012
- Keyless egress meets NHBC Secure Escape
- Lever/Lever Operation
- Winkhaus Thunderbolt Multi-point Lock
- TS007 3* solution comprising 1* key/turn Euro cylinder & 2* protection
- IFH12.89 Venice Stainless Steel Lever
- IFH4.45 Stainless Steel sleeved Letterplate
- IFH4.31 Internal Letterplate Security Cowl
- IFS6.08 Door Chain
- IFS6.30 180deg Door Viewer¹

PREMIUM FRONT



- PAS24:2022
- BSi Kitemarked
- Secured by Design
- Keyless egress meets NHBC Secure Escape
- Lever/Lever Operation
- Winkhaus Thunderbolt Multi-point Lock
- TS007 3* solution comprising 1* key/turn Euro cylinder & 2* Security Levers
- IFH12.72 2* Security Stainless Steel Lever
- IFH4.46 TS008 Stainless Steel sleeved Letterplate
- IFS6.12 Narrow Style Door Chain
- IFS6.30 180deg Door Viewer¹





Official Police Security Initiative

EXTRA CARE FRONT



- PAS24:2022
- BSi Kitemarked
- Secured by Design
- Keyless egress meets NHBC Secure Escape
- Lever/Pad Operation
- Self-Latching
- Winkhaus AV4 Auto-fire Multi-point Lock²
- Option to wire to remote unlocking access control
- TS007 3* solution comprising 1* key/extra care turn Euro cylinder & 2* Security Lever/Pad
- IFH12.99P 2* Security Stainless Steel Lever/Pad
- IFH4.46 TS008 Stainless Steel sleeved Letterplate
- IFS6.12 Narrow Style Door Chain
- IFS6.30 180deg Door Viewer¹





Official Police Security Initiative

UPGRADE FRONT



- PAS24:2022
- BSi Kitemarked
- Secured by Design
- Keyless egress meets NHBC Secure Escape
- Pull Bar Operation
- Self-Latching
- Winkhaus AV4 Auto-fire Multi-point Lock²
- Option to wire to remote unlocking access control
- TS007 3* solution comprising 1* key/turn Euro cylinder & 2* Escutcheon
- IFK2.57 Stainless Steel Guardsman Pull Handle
- IFH4.46 TS008 Stainless Steel sleeved Letterplate
- IFS6.12 Narrow Style Door Chain
- IFS6.30 180deg Door Viewer¹

Official Police Security Initiative



¹ Can be omitted if clear glass is in / beside the door.

² Heritage position locks available.

EXTERNAL DOOR HARDWARE

STANDARD REAR/UTILITY

- PAS24:2022
- BSi Kitemarked
- Secured by Design
- Lever/Lever Operation
- Winkhaus Thunderbolt Multi-point Lock
- TS007 3* solution comprising 1* key/turn Euro cylinder & 2* protection
- IFH12.89 Venice Stainless Steel Lever

PREMIUM REAR/UTILITY

- PAS24:2022
- BSi Kitemarked
- Secured by Design
- Lever/Lever Operation
- Winkhaus Thunderbolt Multi-point Lock
- TS007 3* solution comprising 1* key/turn Euro cylinder & 2* Security Levers
- IFH12.72 2* Security Stainless Steel Lever

OPEN-OUT REAR/UTILITY

- PAS24:2022
- BSi Kitemarked
- Secured by Design
- Lever/Lever Operation
- Winkhaus Thunderbolt Multi-point Lock
- TS007 3* solution comprising 1* key/turn Euro cylinder & 2* Security Levers
- IFH12.72 2* Security Stainless Steel Lever
- Hinge Dog bolts

BIN STORE

- Push Button Digital Lock
- Size 2-4 Overhead Door Closer
- Stainless Steel Kickplates & Pushplates
- Pull Handle
- Stainless Steel Ball Bearing Hinges
- Double Bin Store Doors supplied with Tower Bolt and Monkey Tail Bolt

HINGES

For when a project has varied needs we can make doorsets using a range of different hinge options.

STAINLESS STEEL BALL BEARING BUTT HINGE

IFL4.13 100x75x3mm

Satin Stainless Steel EN
Polished Stainless Steel 1935 (2002) C13
Electro Brassed

UK CA 376114013

WINKHAUS ECO-HINGE

102x84mm

Satin Stainless Steel EN
1935 C10

UK CA 273114010

EVOLUTION SPACE SAVING 2D DOOR HINGE

- Tested in PAS24:2022
- 100,000 cycles with 80kg door
- Adjustable left-right
- Magnetic Cover Cap

PRO-SECURE 3D DOOR HINGE

IFL73.25

- Successfully tested to PAS24 without the need for additional hinge protectors
- Stainless steel hinge pin
- Screw fixings secure through the over-rebate and fix into bosses
- 3D Adjustable to ensure optimal weather tightness and installation

ALTERNATIVE EXTERNAL DOOR HARDWARE OPTIONS

No need to compromise on style, if you've a specific hardware configuration in mind we can often accommodate it whilst still maintaining security credentials.

Stainless Steel Lever on Rose can be used with AV4 Lock with escutcheons



Centre Door Knobs can be used with AV4 Lock instead of pull handles

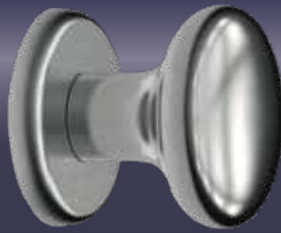

Security Cylinder Pulls can be used instead of escutcheons and pull handles with AV4 lock.



EURO PROFILE ESCUTCHEON



Satin Stainless Steel
Polished Stainless Steel
Satin Aluminium



Non-security Escutcheons can be used with 3* cylinders.

EURO PROFILE CYLINDERS IFM4.46/47

- EN1303 TS007 3* rated
- Kitemarked



ENHANCED SECURITY CYLINDERS

Upgraded Sold Secure Diamond Standard cylinders can be supplied with our doorsets



We are happy to discuss keyed alike cylinders and Master Keyed Systems should they be a requirement.

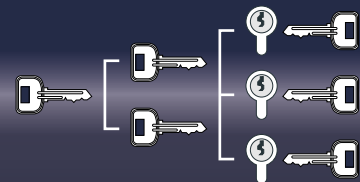

IFS6.17 SPACE SAVING DOOR CHAIN



No face fixing to frame so won't interfere with tight plaster line.

- Chain can hang on lug on wall out of the way when not in use.
- Frame part fixed in PVC frame, shaped to fit Eurocell Profile
- Self tapping screws provided
- Narrow opening gap for added security and safety.
- Easier to fit than other styles

COMING SOON:

Ask about Smart Cylinders and Parcel Boxes



SMART FROM THE START

FINISHING TOUCHES

<p>75MM NUMERALS</p> <p>IFH5.50</p>  <p>Satin Stainless Steel Polished Stainless Steel</p>	<p>75MM NUMERALS</p> <p>IFH5.14</p>  <p>Polished Chrome Satin Chrome Polished Brass</p>	<p>SELF ADHESIVE PLASTIC NUMERALS</p> <p>IFH5.24 50mm IFH5.44 100mm</p>  <p>Polished Chrome Black 50mm</p>	<p>RAISED NUMERALS</p> <p>IFH5.75 150mm</p>  <p>Concealed Fix Satin Stainless Steel Satin Gold</p>
---	--	---	---

SLATE EFFECT NUMERAL PLATES

Available in various sizes, with or without screw holes, in a range of font styles & colours.



NUMERAL PLATE

IFH5.60

To take up to three 50mm black self adhesive numerals

Polished Chrome
Antique Brass



VICTORIAN RECTANGULAR BELL PUSH

IFH4.33

Polished Chrome
Polished Brass



CONTEMPORARY ROUND BELL PUSH

IFH4.37

Polished Chrome
Polished Brass
Satin Chrome
Satin Gold
Antique Bronze



RING STYLE KNOCKER

IFH4.28

Polished Chrome
Polished Brass



150MM URN STYLE FACE FIXED KNOCKER

IFH5.20

Polished Chrome
Satin Chrome
Polished Brass

IFH5.21 version includes hole for door viewer



UPRIGHT NARROW STYLE KNOCKER

IFH4.36

Polished Chrome
Satin Chrome
Polished Brass



CAVITY CLOSER SYSTEM



External Door Fixings Pack – Masonry build using Structural Cavity Closer System

- 200 grade high density insulation is strong enough to screw straight into to provide secure doorset fixing whilst maintaining the required thermal performance characteristics.
- Suits 100mm wide cavities in traditional cavity brick/block or block / block details. (Other sizes are available on request)
- Supplied complete with brick ties.
- Yellow location stickers provided to ensure correct positioning of the doorframe.
- Supplied in packs which include 2no 2.45m lengths of cavity closer for trimming on site, with 20no brick ties.
- Fixing Straps available as optional extra, see below.

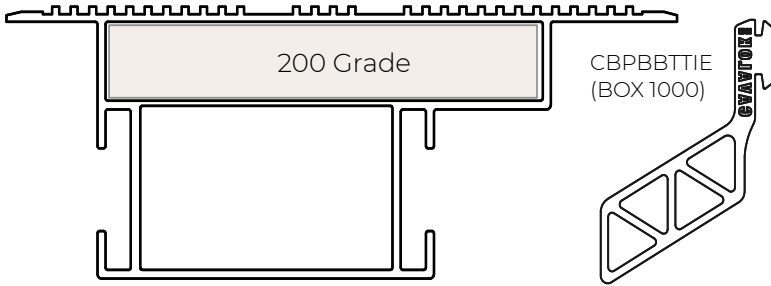

2 x STRUCTURAL 100MM, PROVIDED IN 2.45M LENGTHS.
(TO BE TRIMMED ON SITE TO SUIT OPENING HEIGHT)
32 x BRICK TIES (CBPBBTIE) - 16 PER JAMB

EXTERNAL DOOR FIXING PACKS

Solutions for every build type - ready to install, built to last.

Available fixing pack options include:

- Traditional Masonry
- Structural Cavity Closer
- In-Check
- Block Return Detail
- Timber Frame Kit
- Timber Fire-Stop

We can also tailor fixing packs to suit specific construction details and materials - ask your Sales Representative for more details.

Benefits:

- All fixings required included.
- Designed for a perfect fit with our door sets.
- Reduces installation time and waste.
- Fully compliant with current building regulations.

One pack per doorset - contains all fixings needed to suit your chosen method of installation.



DOORSET PROTECTION

Site-ready protection for every build stage

Our range of doorset protection products keeps your installations looking their best – safeguarding them from scratches, dents, dust, and paint splashes during the build.

DOOR BAGS

- Supplied with every door as standard.
- Breathable polythene, fully recyclable.
- Protects from dust, plaster, paint, and light impact.

TWINFLUTE SHEETS

- Lightweight, rigid fluted plastic.
- Easily cut to size for full coverage.
- Reusable and recyclable.

PADDED PROTECTION JACKETS

- Premium cushioning for extra protection.
- Velcro fastening for a snug fit.
- Option of clear information pocket.

SILL PROTECTION

- Sill covers to suit a range of options.
- Bespoke sill cover available for 2 part sill.
- Reduce risk of damage during build.

BENEFITS OF OUR PROTECTION RANGE:

- Reduces snagging and rework costs.
- Maintains a professional site appearance.
- Simple to apply and remove.

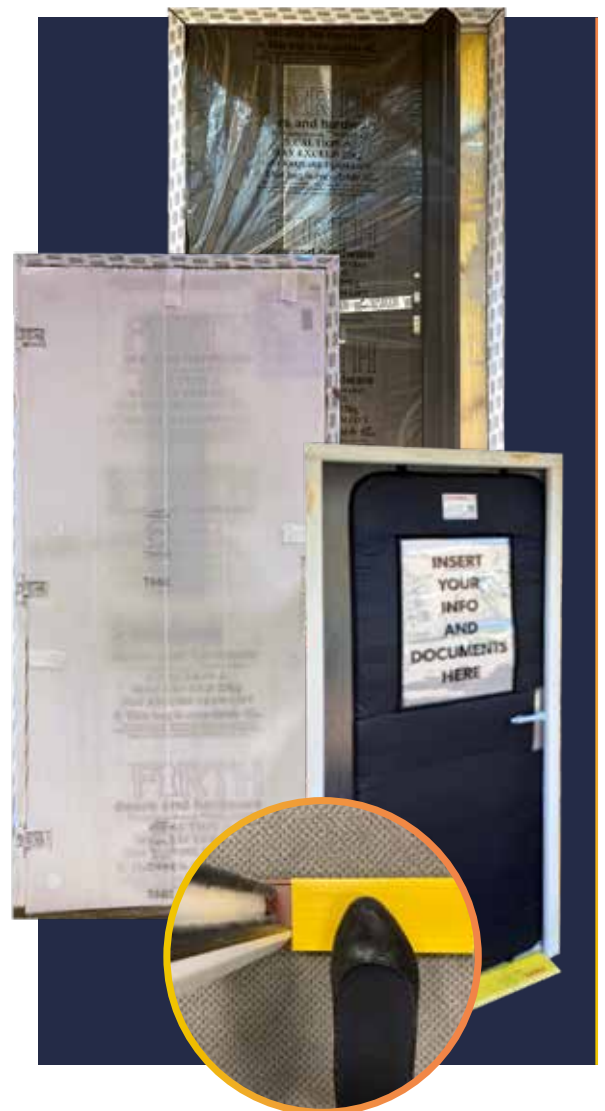

SITE WELCOME PACKS

EVERYTHING YOU NEED FOR A SMOOTH START

When we start supplying a new development, we provide every site team with a comprehensive welcome pack. We can even tailor these to your specific company preferences, construction details and branding - ensuring your team gets exactly the information they need in a format they recognise.

YOUR WELCOME PACK INCLUDES:

- CALL-OFF & DELIVERY PROCESS – step-by-step guidance on ordering.
- DELIVERY PACKING DETAILS – clear illustrations of how your doorsets will arrive.
- DO'S & DON'TS FOR SITE STORAGE & HANDLING – avoid damage, delays, and unnecessary costs.
- INSTALLATION GUIDANCE – practical tips to ensure a perfect fit first time.
- HARDWARE INFORMATION – what's included and how to fit it.
- TROUBLESHOOTING GUIDES – quick answers to common queries.
- AFTER-SALES PROCEDURES – how to request support or replacements.



SETTING YOUR SITE UP FOR SUCCESS!

IRONMONGERY

IT'S WHAT WE DO!

WITH OVER 40 YEARS EXPERIENCE IN SOURCING DIRECTLY FROM THE FACTORIES, WE CAN SUPPLY TO ANY TASTE, DESIGN TREND, PATTERN AND FINISH.



Lever furniture can be made using steel, aluminum or zinc base materials to suit all budgets. We employ GAI trained estimators schedules from technical drawings so that all items of hardware required will be delivered in plot lots.



	A	B	C	D	E	F	G	H	I	J	K	L	M	Units	Total Qty
1	Customer	AN Housebuilder		D02 Cloaks/WC											
2	Site	St Gemma's Gardens		D03 Lounge											
3	Date	05/05/2025		D04 Kitchen											
4	Pack	2nd Fix Ironmongery		D05 Utility											
5	Housetype	Richmond		Bed 3											
6				D08 En Suite											
7	Raven CP Latch		IFH41.04CP	D06 Bed 2										Set	6
8	Raven CP Bathroom		IFH41.05CP	D10 Bed 3										Set	3
9	65mm PSS Tubular Latch		IFM51.0165PSSSS	D11 Bathroom										Each	6
10	65mm PSS Bathroom Lock		IFM51.0765NPSS	D12 Cupboard										Each	3
11	75mm CP Button Tipped Hinges		IFL3.03BT75CP											Pair	14.5
12	CP Oval Door Stop		IFH5.05CP											Each	6
13	CP Handrail Bracket		IFH5.16CP											Each	6
14	CP Hat & Coat Hook		IFH5.16CP											Each	3
15	Roller Catch		IFS5.13											Each	1
16	38mm CP Cupboard Knob		IFH4.1938CP											Each	1





DARE TO BE DIFFERENT

- Polished Chrome
- Satin Chrome
- Matt Chrome
- Satin Nickel
- Matt Nickel
- Black Nickel
- Matt Black
- Rose Gold
- Satin Brass
- Polished Brass
- Polished Stainless Steel*
- Satin Stainless Steel*
- Satin Adonised Aluminium*

* Limited patterns

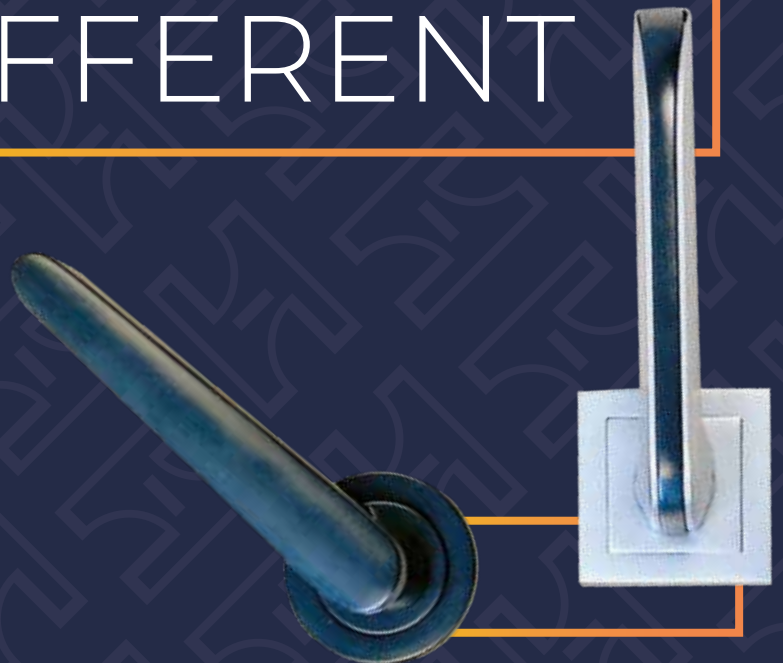

Cant see what you are looking for?

Let us help - contact us and we'll happily work with you to find your perfect lever design.

SAME TIMELESS STYLE LEVER

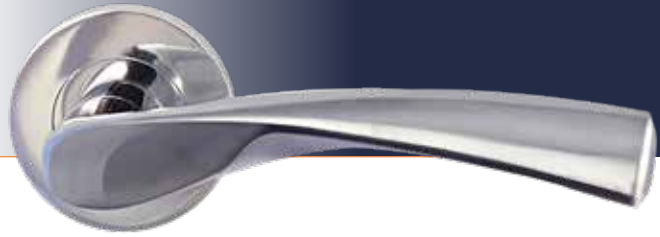

Three specifications:

✓ SUPER E SERIES

- Steel backplate
- Nylon rose
- Steel push-on cover
- Aluminium lever
- Screw fixings

✓✓ ECO RANGE

- Steel backplate
- Zinc screw rose
- Aluminium lever
- Bolt-thru fixings

✓✓✓ DESIGNER RANGE

- Zinc backplate
- Zinc screw rose
- Zinc lever
- Bolt-thru fixings

✓ ZETA
Backplate
IFHE32.04 Latch
IFHE32.05 Bathroom
Polished Chrome

✓✓ SWIFT
Lever on Backplate
IFHE41.04 Latch
IFHE41.05 Bathroom
Polished Chrome

✓✓✓ RAVEN
Lever on Backplate
IFH41.24 Latch
IFH41.25 Bathroom
Polished Chrome

✓ ZETA
Lever on Round Rose
IFHE32.06
Polished Chrome

✓✓ SWIFT
Lever on Round Rose
IFHE41.06
Polished Chrome

✓✓✓ RAVEN
Lever on Round Rose
IFH41.26
Polished Chrome

Other finishes can be supplied for projects. Ask for more details.

DUAL FINISH
LEVERS
ON A VARIETY
OF PLATES



✓✓ PEREGRINE

Lever on backplate
IFHE42.04 Latch
IFHE42.05 Bathroom
Polished Chrome
Satin Nickel



✓✓ PEREGRINE

Lever on round rose
IFHE42.06
Polished Chrome
Satin Nickel

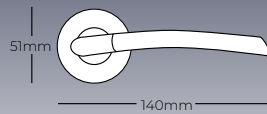

✓✓ MERLIN

Square rose lever
IFH20.69
Polished Chrome /
Satin Nickel

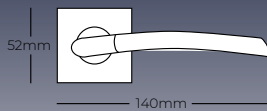

✓✓ FALCON

Lever on Round Rose
IFH20.45
Polished Chrome /
Satin Nickel

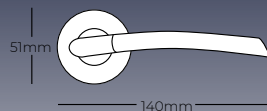

See page 47 for matching
Escutcheons & Bathroom
Turn & Release sets

See page 48 for hinges.

TURQUOISE

Lever on Round Rose

IFH20.23

Polished Chrome /
Satin Chrome

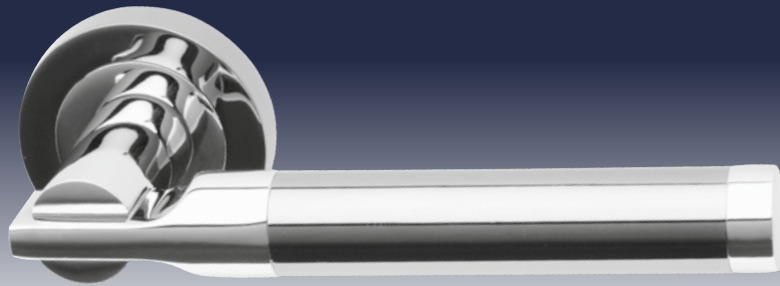
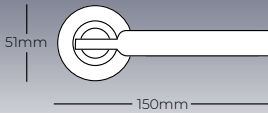

SALISBURY

Lever on Round Rose

IFH20.62

Polished Chrome /
Satin Nickel

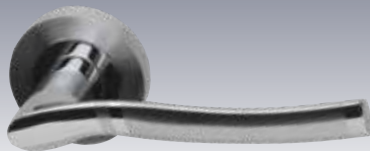
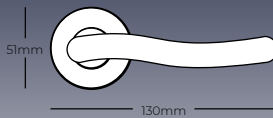

LINCOLN

Lever on Round Rose

IFH20.66

Polished Chrome /
Satin Chrome

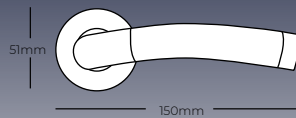

JADE

Lever on Round Rose

IFH20.35

Polished Chrome /
Satin Chrome

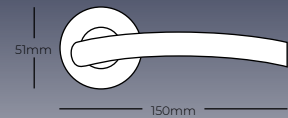

RUBY

Lever on Round Rose

IFH20.24

Polished Chrome /
Satin Chrome

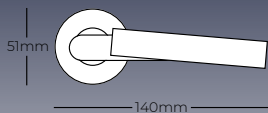

SOLITAIRE

Lever on Round Rose

IFH20.10

Polished Chrome /
Satin Chrome

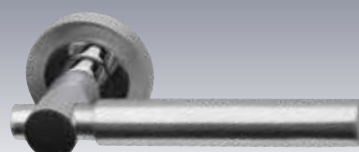
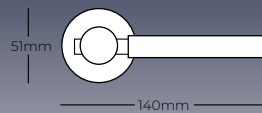

ENTERPRISE

Lever on Round Rose

IFH20.44

Polished Chrome /
Satin Chrome
Polished Chrome /
Black Nickel

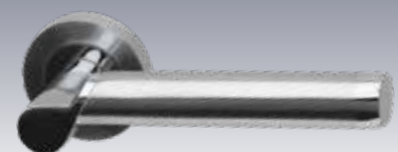
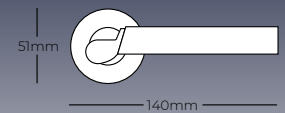

TURQUOISE

Lever on Round Rose

IFH20.23

Polished Chrome /
Black Nickel

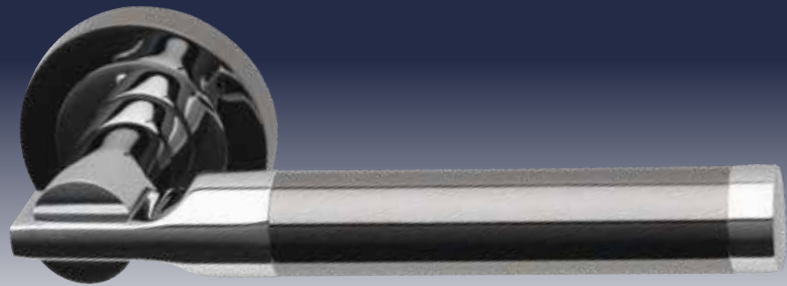
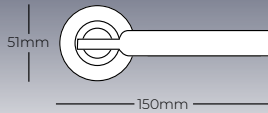

CANTERBURY

Square on Round Rose

IFH20.64

Polished Chrome /
Satin Chrome

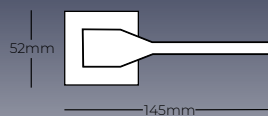

GEMINI

Square on Rose Lever

IFH50.56

Polished Chrome
Satin Chrome Plated

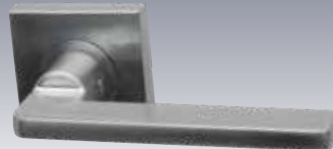
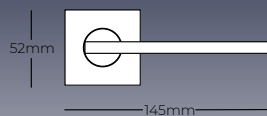

SHERINGHAM

On Rose

IFA1.01

Satin Aluminium

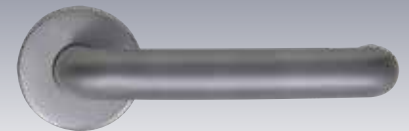
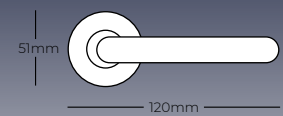

LYNX

Lever on Round Rose

IFH20.36

Polished Chrome
Satin Chrome

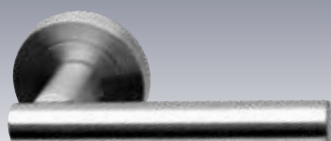
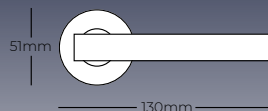

SATURN

Lever on Round Rose

IFH20.06

Satin Stainless Steel
Polished Stainless Steel

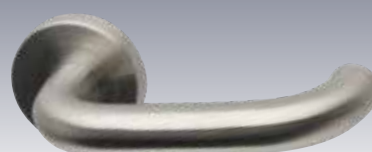
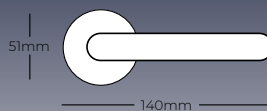

SOLAR

Lever on Round Rose

IFH20.20

Satin Stainless Steel
Polished Stainless Steel

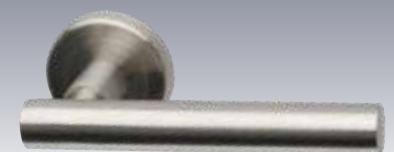
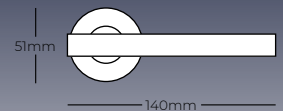

ORION
Lever on Round Rose
IFH20.27
Polished Chrome
Satin Chrome

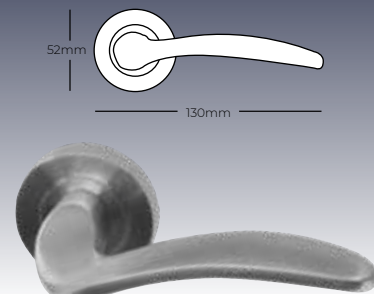

GALAXY
Lever on Round Rose
IFH20.42
Polished Chrome
Satin Chrome



BANBURY
Lever on Round Rose
IFH20.09
Polished Chrome
Satin Chrome

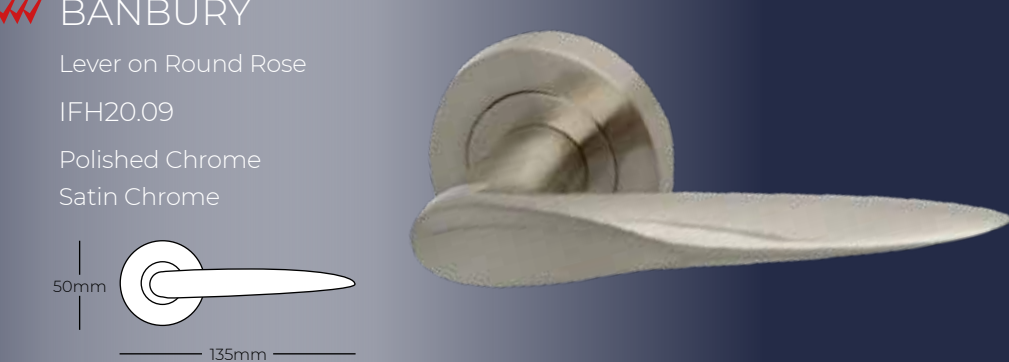

LUNAR
Lever on Round Rose
IFH20.01
Polished Chrome

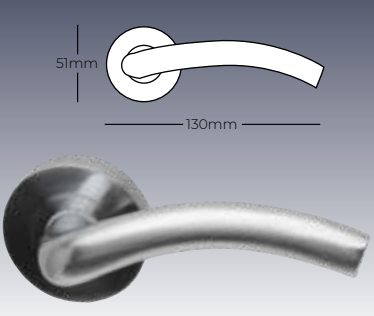

NEPTUNE
Lever on Round Rose
IFH20.04
Polished Chrome
Satin Chrome
Polished Brass

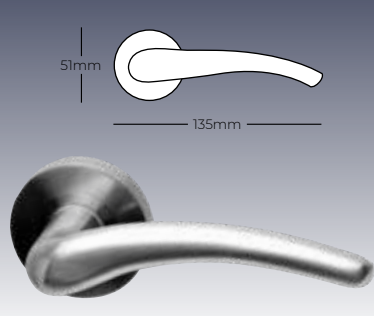

✓✓ **STARLING**
Lever on Round Rose
IFHE44.06
Polished Chrome

✓ **KAPPA**
Lever on Round Rose
IFHE33.06
Polished Chrome
Satin Nickel

✓ **SIGMA**
Lever on Round Rose
IFHE36.06
Polished Chrome

✓✓ **ALPINE**
Lever on Round Rose
IFH20.41
Polished Chrome
Satin Chrome

✓ **BETA**
Lever on Round Rose
IFHE35.06
Polished Chrome
Satin Nickel

Backplate Patterns to cater for all budgets

ROMA
Backplate
IFH19.17 Long Latch
IFH19.14 Short Latch
IFH19.15 Bathroom
IFH19.11 Lock
Polished Chrome



VICTORIAN SCROLL
Backplate
IFH7.24 Latch
IFH7.26 Bathroom
IFH7.21. Lock
Polished Chrome
Polished Brass



ANGELICA
Lever on Backplate
IFH9.34 latch
IFH9.35 Bathroom
Polished Chrome



DEVINE
Backplate
IFH8.84 Latch
IFH8.85 Bathroom
IFH18.81 Lock
Polished Chrome



CURLEW
Lever on Backplate
IFHE43.04 Latch
IFHE43.05 Bathroom
Polished Chrome



CAPRI
Backplate
IFH16.04 Latch
IFH16.05 Bathroom
IFH16.01 Lock
Polished Chrome
Satin Chrome



FLORENCE
Backplate
IFH1.09 Latch
IFH1.12 Bathroom
IFH1.10 Lock
Polished Chrome
Satin Chrome
Polished Brass

TRIESTE
Backplate
IFH10.24 Latch
IFH10.25 Bathroom
IFH10.21 Lock
Polished Chrome
Satin Chrome
Polished Brass

STAFFORD
Backplate
IFH2.01 Latch
IFH2.04 Bathroom
IFH2.02 Lock
Polished Chrome
Satin Chrome
Polished Brass

SORRENTO
Backplate
IFH12.08 Latch
IFH12.09 Bathroom
Polished Chrome
Satin Chrome
Polished Brass

ESCUTCHEONS & BATHROOM
Turn and Release sets

52mm	52mm	52mm	52mm
Bathroom Thumbturn & Release Set	Super E Series Thumbturn & Release Set	Key Escutcheons	Euro Escutcheons

Square rose escutcheons also available.

LIGHT DUTY HINGES

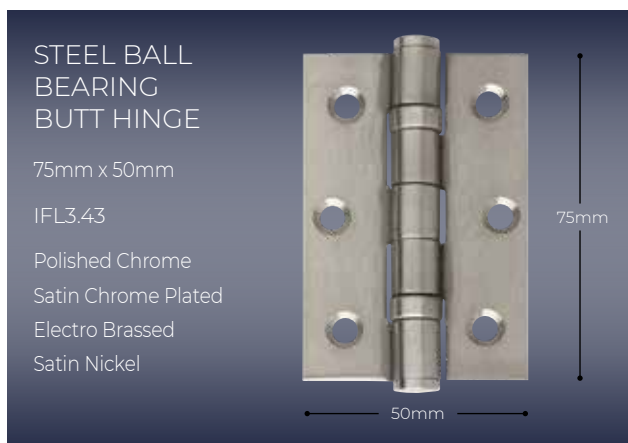
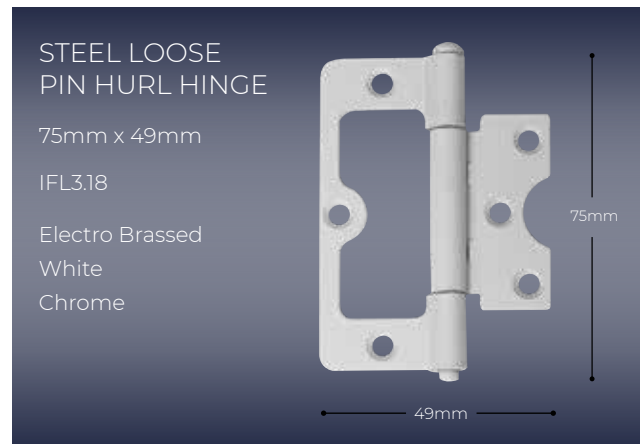
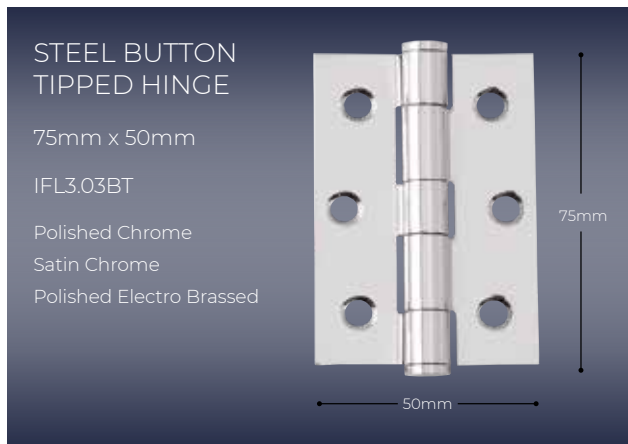

FIRE DOOR HINGES

Fully tested range of butt hinges, fire tested therefore suitable for FD30 doors.

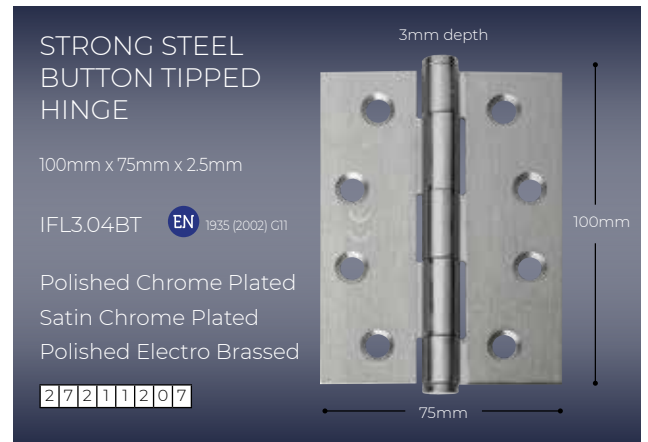

Radiused cornered hinges available

ECO PACK HARDWARE

Contains all the ironmongery you need to complete your doorset.
Can also include doorstops, coat hooks, bolts, cupboard knobs, pull handles, etc.



CONTRACT RANGE LOCKS & LATCHES

One of the most comprehensive ranges of housing quality locks and latches on the market.

TUBULAR MORTICE LATCH

IFM51.01  EN 12209



From 65mm

	PB	PSS
IFM5101 - 65mm	✓	✓
IFM51.01 - 75mm	✓	✓

UPRIGHT MORTICE LATCH

IFM51.03  EN 12209



From 65mm

	PB	PSS
IFM5103 - 65mm	✓	✓
IFM5103 - 75mm	✓	✓

MORTICE BATHROOM LOCK

IFM51.07  EN 12209



From 65mm

	PB	PSS
IFM5107 - 65mm	✓	✓
IFM51.07 - 75mm	✓	✓

MORTICE LOCKING LATCH







IFM51.09  EN 12209



From 65mm

	PB	PSS
IFM5109 - 70mm	✓	✓

STRIKE PLATES ROUNDED & SQUARE

	PB	PSS	IFM52.07	IFM52.11	IFM52.13	IFM52.14	IFM52.18	IFM52.19
IFM52.07	✓	✓						
IFM52.11	✓	✓						
IFM52.13	✓	✓						
IFM52.14	✓	✓						
IFM52.18	✓	✓						
IFM52.19	✓	✓						
IFM52.35	✓	✓						
IFM52.37	✓	✓						

TO SUIT: IFM51.05, IFM51.07, IFM51.08, IFM51.13, IFM51.05, IFM51.07, IFM51.08, IFM51.13, IFM51.03, IFM51.01, IFM51.03, IFM52.35, IFM51.11, IFM51.12, IFM51.14, IFM51.11, IFM51.12, IFM51.14







Long tongue version available

12MM REBATE SETS

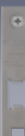
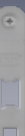
	PB	PSS	TO SUIT
IFM52.05	✓	✓	IFM51.03 IFM51.03 51.07 51.08 51.13
IFM52.09	✓	✓	IFM52.09 IFM51.05
IFM52.10	✓	✓	IFM52.10 IFM51.01
IFM52.12	✓	✓	IFM52.12 IFM51.09
IFM52.23	✓	✓	IFM52.23 IFM51.11 51.12 51.14

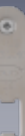
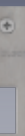

FORENDS ROUNDED & SQUARE

	PB	PSS	IFM52.20	IFM52.24	IFM52.25	IFM52.26	IFM52.27	IFM52.28	IFM52.29	IFM52.32	IFM52.33
IFM52.20	✓	✓									
IFM52.21	✓	✓									
IFM52.24	✓	✓									
IFM52.25	✓	✓									
IFM52.26	✓	✓									
IFM52.27	✓	✓									
IFM52.28	✓	✓									
IFM52.29	✓	✓									
IFM52.32	✓	✓									
IFM52.33	✓	✓									

TO SUIT: IFM51.01, IFM51.05, IFM51.07, IFM51.13, IFM51.05, IFM51.05, IFM51.07, IFM51.13, IFM51.09, IFM51.09, IFM51.03, IFM51.03, IFM51.11, IFM51.12, IFM51.14, IFM51.11, IFM51.12, IFM51.14

NYLON BOX KEEPS

Available separately

IFM52.17 TO SUIT	IFM51.01
	IFM51.03
IFM52.08 TO SUIT	IFM51.05
	IFM51.07
	IFM51.08
	IFM51.13

Satin stainless steel accessories are available to special orders.

FOR LOCKS FOR EXTERNAL DOORS SEE PAGE 33.

MORTICE EURO CYLINDER SASHLOCK CASE

IFM51.08

EN 12209

From 65mm

	PB	PSS
IFM51.08 - 65mm	✓	✓
IFM51.08 - 75mm	✓	✓



MORTICE EURO CYLINDER DEADLOCK CASE

IFM51.12

EN 12209

From 65mm

	PB	PSS
IFM51.12 - 65mm	✓	✓
IFM51.12 - 75mm	✓	✓

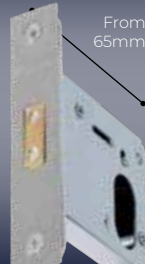

FB1 & FB2 MORTICE DEADLOCK

IFM17.05 - FB2
IFM17.06 - FB1

KEYS CAN BE PURCHASED SEPERATELY

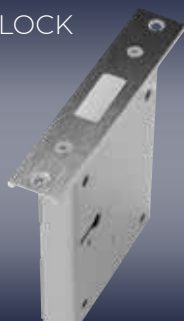

EURO MORTICE NIGHTLATCH CASE

IFM54.14

	PB	PSS
IFM51.12 - 65mm	✓	✓
IFM51.12 - 75mm	✓	✓



LEVER MORTICE SASHLOCK

IFM54.21

	PB	PSS
IFM51.12 - 65mm	✓	✓
IFM51.12 - 75mm	✓	✓



LEVER MORTICE DEADLOCK

IFM54.20

	PB	PSS
IFM51.12 - 65mm	✓	✓
IFM51.12 - 75mm	✓	✓



NON BS3621 5 LEVER AND 3 LEVER SASHLOCKS & DEADLOCKS ARE ALSO AVAILABLE.

ROLLERBOLT RIM NIGHTLATCH

IFM18.07

	PB	PSS
IFM51.12 - 65mm	✓	✓
IFM51.12 - 75mm	✓	✓



DEADLOCK RIM NIGHTLATCH

IFM18.06

	PB	PSS
IFM51.12 - 65mm	✓	✓
IFM51.12 - 75mm	✓	✓



PB = POLISHED BRASS

PSS = POLISHED STAINLESS STEEL

SSS = SATIN STAINLESS STEEL

CP = POLISHED CHROME PLATED

SCP = SATIN CHROME PLATED

DOOR STOPS

PROJECTING DOORSTOP

IFH5.06 Electro Brassed
IFH5.07

Sizes 75mm

Chrome Plated
Satin Chrome Plated

Sizes 75mm



FLOOR MOUNTED DOORSTOP (OVAL)

IFH5.05

Electro Brassed
Chrome Plated
Satin Chrome Plated



SPRING TYPE DOORSTOP

IFH7.39

Electro Brassed
Chrome Plated



FLOOR MOUNTED DOORSTOPS

IFA3.30

Satin Anodised Aluminium
Satin Stainless Steel Finish
Polished Stainless Steel Finish

Sizes 16mm
SIZES 25mm/40mm
SIZES 25mm/40mm



PULL KNOBS & BRACKETS

ALUMINIUM 'D' HANDLES

IFK3.12 152mm
Satin Aluminium



ALUMINIUM BOW HANDLES

IFK3.105 152mm
Satin Aluminium



CUPBOARD KNOBS (Solid)

IFH4.19

Polished Brass
Chrome Plated
Satin Chrome Plated
Satin Nickel Plated

SIZES 25mm | 32mm | 38mm | 42mm | 50mm



HANDRAIL BRACKET (Heavy Duty)

IFH5.16

Electro Brassed
Chrome Plated
Satin Chrome Plated



ESCUTCHEONS

ESCUTCHEON (OPEN)

IFS4.01

35mm Diameter

Polished Brass
Chrome Plated
Satin Chrome Plated



ESCUTCHEON (COVERED)

IFS4.02

35mm Diameter

Polished Brass
Chrome Plated
Satin Chrome Plated



ESCUTCHEON

IFH20.07

Euro or Key Profile

Polished Chrome
Satin Chrome

5mm



HOOKS

HAT & COAT HOOK

IFH5.01

Polished Brass
Chrome Plated
Satin Chrome Plated



SINGLE ROBE HOOK

IFW11.01

Brass Plated
Chrome Plated



DOUBLE ROBE HOOK

IFW11.02

Brass Plated
Chrome Plated



HAT & COAT HOOK STRIP PATTERN

IFD3.17

Satin Aluminium



WARDROBE & CONTRACT BATHROOM FITTINGS

END BRACKETS

IFY4.01

20mm Ø

Chrome Plated



CENTRE BRACKETS

IFY4.02

20mm Ø

Chrome Plated



END SOCKETS

IFY4.03

20mm Ø

Chrome Plated



HOLLOW TUBE

IFY4.04

20mm Ø

Chrome Plated



TOILET ROLL HOLDER

IFY3.01

Brass Plated
Chrome Plated



TOWEL RING

IFY3.02

Brass Plated
Chrome Plated



BOLTS AND CATCHES

MORTICE DOOR SECURITY BOLT

Square forend and Radius forend available.

IFS4.06

Electro Brassed
Nickel Plated

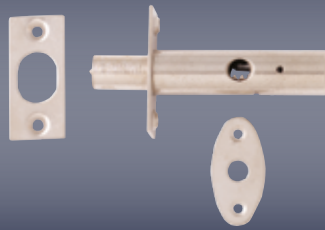

STRAIGHT BARREL BOLTS

IFS1.02

Polished Brass
Chrome Plated

76 x 25mm
102 x 25mm
152 x 25mm



KEY TO SUIT MORTICE BOLT

IFS4.07



NECKED BARREL BOLTS

IFS1.07

Polished Brass
Chrome Plated

76 x 25mm
102 x 25mm
152 x 25mm



OVAL THUMBTURN FOR MORTICE BOLT

IFS4.09

Polished Brass
Chrome Plated
Satin Chrome



LEVER ACTION FLUSH BOLTS

Polished Polished Brass
Polished Chrome Plated

IFS1.13
152mm



Easy clean sockets are also available.

HEAVY DUTY ADJUSTABLE ROLLER CATCH

IFS5.14

Polished
Stainless Steel
Polished
Brass Finish



LIGHT DUTY ROLLER CATCH

IFS5.13

Brassed
Nickel
Plated



MAGNETIC CATCHES

IFS5.12

White



DORMA T93B

Slide arm overhead door closer with stainless steel cover

Power size 2-5, suitable for FD30 and FD60 doors

Backcheck & Delayed Action with adjustable closing & latching speeds

Suitable for Open-in and Open-out doors

EN
1154
1634
Fire Test

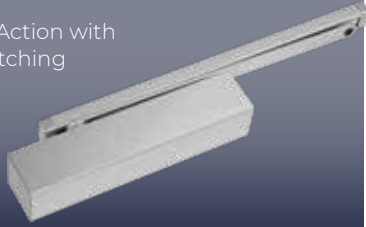

CONCEALED JAMB DOOR CLOSER

Included in a successful 30 minute fire test to BS476 Part 22 1987

IFN13.02

Electro Brassed
Nickel Plated



SIZE 2-5 OVERHEAD DOOR CLOSER

Adjustable backcheck and delayed action.

IF.SN.05

Silver
Satin Stainless Steel
Polished Stainless Steel
Polished Brass

EN
1154
1634
Fire Test

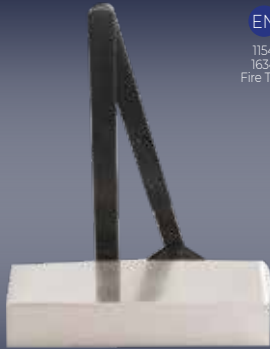

CONTRACT SIZE 3 OVERHEAD DOOR CLOSER

IF.SN.03

Silver
Gold

EN
1154
1634
Fire Test

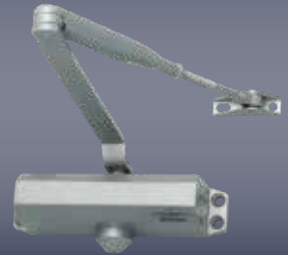

PANIC HARDWARE



Also available
FIRE DOOR SIGNAGE
Ask our sales office for details





Thanks to our strong partnerships with top mailbox suppliers, we are able to offer an extensive selection of products that meet a variety of design specifications, including TS009, Secured by Design, and Fire Ratings where applicable. No matter your requirements or available space, we are here to help you find the perfect solution.





NEW

Grade 304
Satin Stainless Steel
Bathroom Fittings

IFY3.05
400mm Towel Rail

IFY3.06
155mm L-Shaped Toilet
Roll Holder

IFY3.07
180mm C-Shaped Toilet
Roll Holder

IFY3.08
50mm dia Robe Hook

IFY3.09
45x45mm Square
Self-adhesive Handy Hook

SLEEK
FUNCTIONAL
EFFORTLESSLY BEAUTIFUL



Our latest collection of designer bathroom fittings brings modern elegance to any WC or Bathroom.

With premium materials and precision engineering, each piece is designed to perform brilliantly while making a bold statement in style.

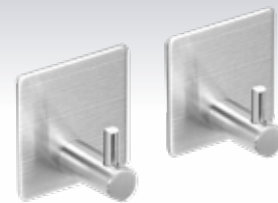

TEE HINGES

Black finish
(galvanised finish also available)
IFL7.09

250mm
300mm
350mm
400mm



HASP & STAPLE

Black finish (galvanised finish also available)

IFS2.20

100mm
150mm
200mm

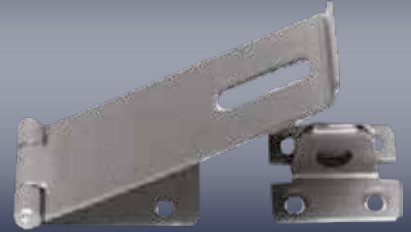

TOWER BOLT

Black finish
(galvanised finish also available)
IFS2.02

100mm
150mm
200mm
250mm

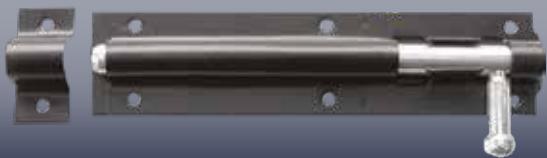

BRENTON TYPE PADBOLT

Black finish
(galvanised finish also available)

IFS2.09

150mm
200mm



AUTO GATE LATCH

Black finish
(galvanised finish also available)
IFS2.21

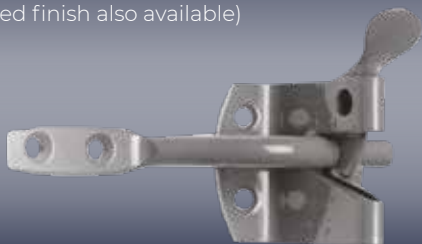

SUFFOLK LATCH

Black finish
(galvanised finish also available)
IFS2.22



TWISTED RING GATE LATCH

Black finish
(galvanised finish also available)
IFS2.26



PLAIN RING GATE LATCH

Black finish
(galvanised finish also available)
IFS2.25

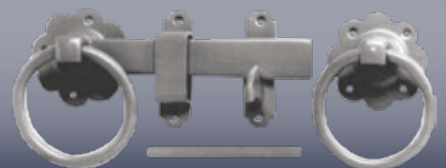

INTERNAL DOORS

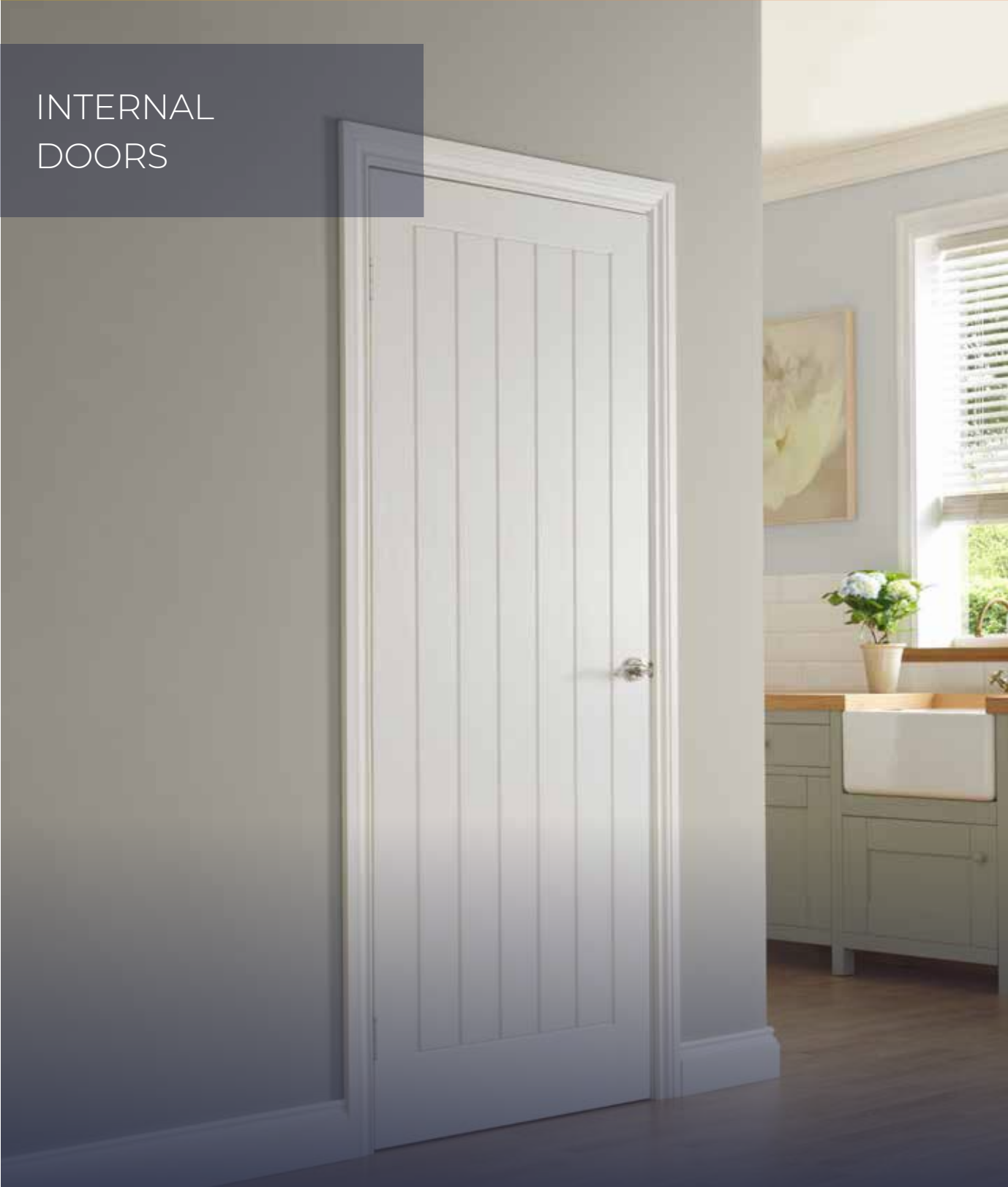

WE CAN OFFER A WIDE RANGE OF INTERNAL DOORS, FROM OUR SPECIALIST SUPPLY PARTNERS, ALONG WITH OUR IN-HOUSE SCHEDULING SERVICE AND CALL-OFF ORDERING SYSTEM SO THAT YOUR DOORS ARRIVE ON SITE IN PLOT LOTS ALONG WITH THE IRONMONGERY NEEDED. OUR TEAM ARE FULLY TRAINED AND HAPPY TO DISCUSS YOUR REQUIREMENTS

K+ INTERNAL DOORS

A NO NONSENSE SOLUTION TO FITTING INTERNAL DOORS INTO TWO STOREY HOMES.

Textured 6 panel design

610 x 1981 x 35mm

686 x 1981 x 35mm

762 x 1981 x 35mm

838 x 1981 x 35mm

Medium weight construction.

Moulded textured skin.

Primed for on-site painting.

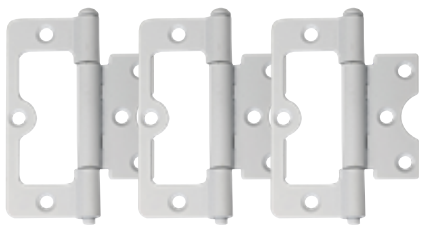

KV.08 Ripon K+ 6 panel textured



Works well with non-mortice hurl hinges (page 48) and our Contract Range of tubular latches and bathroom locks (page 50) when fitting to standard softwood/MDF door linings.

Pair with a lever handle chosen from our extensive range for the complete solution - see pages 40 to 47.



All products shown on this page are FSC Mix

MOULDED DOORS



IFV.08 Ripon 6p Textured
IFV.07 Elland 6p Smooth



IFV.17 York 4p Textured
IFV.30 Leyburn 4p Smooth



IFV.67 Thirsk 5p Vertical Textured
IFV.04 Halifax 5p Vertical Smooth



Standard Core, Semi-Solid are FSC mix 70%
Safe 'n' Sound, FD30,FD60 are 70% PEFC Certified



IFV.41 Silsden Ladder Moulded Smooth



IFV.53 Riverside 5P
Smooth



IFV.56 Malham 2p
Smooth



IFV.11 Cottage Etch Glazed

PREMIUM MOULDED



IFV.76 Settle 1p Smooth



IFV.77 Austwick 4 line Horizontal Smooth



Standard Core, Semi-Solid are FSC mix 70%
Safe 'n' Sound, FD30,FD60 are 70% PEFC Certified



IFV.02S Saltaire
2p Shallow Smooth

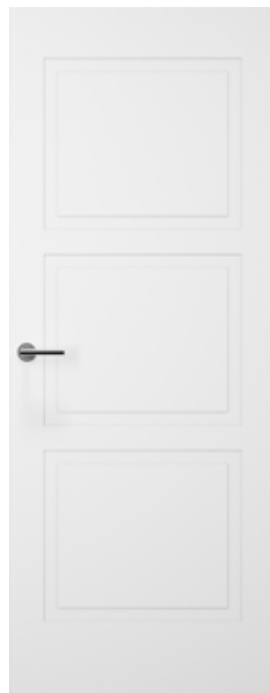

IFV.03S Haworth
3p Shallow Smooth



IFV.37 Manhattan 6 Light White Lead Glazed

FEATURE INTERNAL DOORS



IFU.70 Suffolk Oak



IFU.71 Suffolk Glazed



All products shown on this page are FSC Mix

Engineered Oak Veneered Internal Doors available finished or unfinished, 34mm and 44mm fire. Glazed doors fitted with clear or obscure glass, toughened as standard



IFU.74 Milano 4Lite Glazed



IFU.68 Milano Solid



IFU.75 Milano 1 Lite Glazed



IFX.50 Apollo Black 4 panel



IFX.53 Ares Black 3 Lite Glazed



IFX.52 Ares Black 3 Panel Lite Glazed



All products shown on this page are FSC Mix



IFX.55 Rhea Black 4 Lite Glazed



IFX.54 Rhea Black



IFX.51 Apollo Black 4 Lite Glazed - shown as a pair

All glazed doors are fitted with toughened glass as standard which can be clear or obscure

VENEERED INTERNAL DOORS



IFU.94 2 Stile Veneer Match Walnut



IFU.79 White Oak Veneer



IFP.06 4 Line Light Grey



IFV.10 Paint Grade Plus*



Bringing together cutting edge technology with the timeless beauty of real wood, this stunning collection of flush doors can suit a range of interior design schemes.

Can't see what you are looking for?

Ask and our team can advise on a wider range of design that we can source .

IFU.89 2 Stile Oak Veneer Match

IFU.89 2 Stile Oak Veneer Match



All products shown above are 70% PEFC Certified except Standard Core only which are FSC mix 70%.

TECHNICAL DETAILS

Metric sizes are available in some designs.

864mm or wider doors are usually priced more than 838mm and under.

INTERIOR DOOR CONSTRUCTION

Our choice of internal door constructions vary depending on the door you select. We have included some of the popular options to help you choose the right specification for your requirements.

AVAILABLE SIZES

864 x 1981mm	(2' 10" x 6' 6")
838 x 1981mm	(2' 9" x 6' 6")
762 x 1981mm	(2' 6" x 6' 6")
686 x 1981mm	(2' 3" x 6' 6")
610 x 1981mm	(2' 0" x 6' 6")
533 x 1981mm	(1' 9" x 6' 6")
457 x 1981mm	(1' 6" x 6' 6")

DOOR THICKNESS

Standard Doors	35mm thick
FD30 Fire Doors	44mm thick
FD60 Fire Doors	54mm thick



TIMBER DOORSETS FOR EVERY APPLICATION

We can offer high-quality internal timber pre-hung doorsets, designed to meet the needs of modern developments. Available with fire-rated and security-tested options, our doorsets combine safety, performance, and style.

Whether you need apartment entrance doorsets, durable solutions for corridors and stairwells in flats, or inter-connecting doorsets from garages to houses, we provide a complete range tailored to your project requirements.



ENVIRONMENTAL PRODUCTS

BUILDING A SUSTAINABLE FUTURE

OUR COMMITMENT TO THE ENVIRONMENT GOES BEYOND INNOVATION- IT'S ABOUT CREATING HOMES THAT ACTIVELY ENHANCE THE WORLD AROUND THEM. IN THIS SECTION, YOU'LL DISCOVER PRODUCTS DESIGNED TO IMPROVE ENERGY EFFICIENCY, REDUCE ENVIRONMENTAL IMPACT, AND SUPPORT ECOLOGICAL WELLBEING. FROM SMART RESOURCE MANAGEMENT TO ECO-FRIENDLY MATERIALS, EACH SOLUTION IS CHOSEN TO HELP BUILDERS AND HOMEOWNERS CREATE SPACES THAT ARE HEALTHIER, MORE SUSTAINABLE, AND FUTURE-READY.

200LTR WATER BUTT COMPLETE KIT IFY5.02

Supplied as a complete kit comprising:

- Water Butt body with child-proof lid.
- Water butt stand.
- Rain Diverter Kit.

Stand, lid, and diverter kit can be available separately for replacements.



MINI RAINSAVER 100LTR WATERBUTT IFY5.08

Supplied as a complete kit comprising:

- 100 litre capacity.
- At just 380mm (15") wide the Mini Rainsaver® will fit into even the smallest space.
- Perfect for positioning on a patio or in a garden.
- Push-fit lid.
- Supplied with hose-connector tap.
- Fitting is pre-drilled.

220LTR GARDEN COMPOST CONVERTER IFY5.01

- Strong and rigid in construction.
- Needs no site assembly.
- 220ltr capacity.
- Extra wide hatch allows easy access to the finished compost.
- Can be lifted up and off the compost heap.
- Made from 100% recycled Plastic.
- 10 Year guarantee.
- Full instruction leaflet included.
- 740x740x900mm.
- 4.1kg empty.



ALSO
AVAILABLE
IN
330LTR

OUTDOOR LAUNDRY PRODUCTS

3 ARM ROTARY CLOTHES DRYER 35M
 IFY6.16 35m

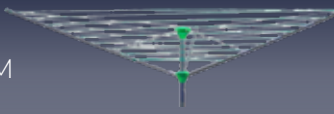

- 32mm single pole dryer.
- Three, heavy-duty rectangular arms.
- Umbrella clip mechanism.
- Turning circle 2.0m dia
- PVC coated /line powder coated steel.
- Plastic ground socket included.

METAL GROUND SPIKE
 IFY6.09



- For 32mm single pole dryer.

WILDLIFE HABITATS

In the drive for Sustainable Homes products are available for enhancing the ecological value of a site. Each site should be evaluated by a suitably qualified ecologist who will recommend products be installed within a development to positively enhance the ecology of the site. The following are examples of such products that could be required.

BIRD BOX 26MM

- Constructed from thick Canadian cedar from managed forests for excellent insulation and strength.
- Deeper interior dimensions offer greater appeal to nesting birds.
- Hinged door for inspection and cleaning.
- Hand assembled in the UK for higher quality finish.
- No painting, varnishing or preservatives required - ever. Ages naturally and attractively and adds style to any garden setting.

H:370mm, W:156mm, D:175mm - 19mm-25mm thickness Canadian cedar - Approx Weight 1.5kg

26mm entrance hole especially for blue tits. Occasionally coal and marsh tits and wrens.



BEE BARN

This new small double chambered insect habitat (top varying size canes - bottom solid bored timber) is ideal for hanging in a sheltered garden or house wall or orchard. This is a general insect habitat. The holes may be used by solitary bees such as or Leafcutter Bees, which are non aggressive and excellent for pollinating in the garden, helping to increase fruit yields. Site using back hanger or central hanging chain if preferred in a sheltered spot, preferably to catch the morning sun.

- The durable roof and solid timber construction give excellent insulations for over wintering Ladybirds and Lacewings.

Full FSC timber construction.



NATURAL TIMBER BAT BOX

This natural and attractive Bat Box will fit into any garden, woodland or house wall site.

It is made from high quality durable timber providing longevity and excellent insulation.

Bats need new habitats as many of their traditional roosts have been lost over recent years. The narrow entrance slot and strong timber help to discourage predators.

- New buildings often require the provision of bat boxes / roosts.

H:380mm, W:180mm, D:100mm
 Approx Weight 1.2kg

Full FSC timber construction.



GALVANIZED CLOTHES POST

IFY6.08

- Standard clothes post.
- Optional ground peg/socket.
- Galvanised heavy-duty tube and socket.
- 2.4m high.



RETRACTABLE WASHING LINE (12M)

IFY6.07

- Easy to use retractable outdoor washing line.
- Stows neatly away when not in use.
- Fully retractable.
- UV stable protective casing.
- 2.4m high.



SCHWEGLER HABITATS

Any Schwegler Products can be supplied to meet site requirements. Here are a selection of most commonly requested products.

BAT BOX 2F (UNIVERSAL)

Can be converted into a Bird Nest Box

MATERIAL: SCHWEGLER Wood-Concrete Nest Box. Hanger: steel, galvanized.

FIXING: Can be installed in a tree or on buildings, minimum height 3 to 4 metres. Ensure that a clear horizontal approach is provided for the Bats. To ensure optimum accommodation, the Bat Box should be cleaned once or twice a year, or the Bat droppings should be removed.



SPARROW ROOST 1SP

Depending on the location, 3 versions of the Sparrow Roost available

OCCUPANTS: House and Tree Sparrows, and in some instances other Birds which use nest boxes such as Tits, Redstarts and Spotted Flycatchers.

MATERIAL: SCHWEGLER wood-concrete.

SITING: On all types of houses in built-up areas, and on industrial and agricultural buildings such as bams, sheds and factories.

INSTALLATION HEIGHT: 2 metres or more above ground level.



HOUSE MARTIN NEST NO. 9B

HANGING SITE: Under eaves on the external wall of buildings.

Please ensure you hang it on side protected from the weather. House Martins do not breed within buildings.



GARDEN BUILDINGS

BUDGET APEX GARDEN SHED

IFY8.05 = 5x4' IFY8.06 = 6x4' IFY8.07 = 7x5' IFY8.08 = 8x6'

Sheds are delivered direct by our supplier's transport, flat packed ready for site assembly and finishing.

All ironmongery included to hang door as viewed below, additional locking hardware can be ordered from the selection shown below.

In order to load more sheds onto one vehicle to keep transport costs

to a minimum, shed panels are not palletised, site will be expected to assist delivery driver in offloading the panels.

Please include site contact name and telephone number on purchase orders to ensure the transport company can contact site prior to delivery.

- ✔ 5x4', 6x4', 7x5', 8x6' available sizes
- ✔ High quality standard timber
- ✔ Green mineralised roofing felt
- ✔ With windows, Sheds without windows are available as a special order.
- ✔ With turn-button catch
- ✔ Supplied for site assembly.



GOLD SECURITY PACK
 150mm Flexible hinged hasp ZP
 63mm 6 lever close shackle padlock

SILVER SECURITY PACK
 50mm Padlock Cylinder Action
 150mm Medium Padbolt Galvanised

BRONZE SECURITY PACK
 100mm Rim Deadlock Grey
 150mm 6" Black Pull Handle

WHEELIE BIN STORES
 IFY8.11
 Single

WHEELIE BIN STORES
 IFY8.12
 Double

WHEELIE BIN STORES
 IFY8.13
 Triple

CYCLE STORAGE

SHEFFIELD BIKE STAND

IFY8.02B = Bolt on IFY8.02C = Concrete in

This tubular cycle stand allows the bike's frame to be secured by the users own lock. This practical and durable design is recommended by national cycling associations.

Surface counter sunk to 250mm depth, this product has spiggots welded to the buried section in order to provide

additional security once concreted in place.

- 48.2mm x 3mm mild steel tube hot dip galvanised to BS EN ISO 1461:1999.
- 800mm (height above ground) x 600mm (width).

Available in 2 types: surface mounted and root fixed.



SEMI-VERTICAL CYCLE STANDS

A great space saving cycle rack with high and low positions to maximise cycle storage.

Available as a standard version with 305mm centres, however as manufacturers we are able to offer this product as a variety of centres. Contact a member of our sales team for more information.

Racks shown are for standard sizes, if you require smaller or bigger racks we are always willing to manufacture these and other bespoke designs.

Cycles are loaded semi-vertically in to trough supports set at alternate high and low position. Comes standard as a surface mounted rack complete with additional trough support bars for extra strength.

A locking loop is provided as standard to enable the cyclist to secure the bike using their own lock for additional security.

- Available as various space stands, minimum 4 spaces.
- Mild steel hot dip galvanised to BS EN ISO 1461:1999.
- 1200mm depth x 1800mm height.
- Made to order and delivered direct to site by the manufacturer.



IFY8.33 – MADE TO ORDER TO SPECIFIC SIZE REQUIRED

bream COMPLIANT SYSTEM

CYCLE SECURITY POST

IFY8.03

Chain and padlock valuables to secure strong metal post.

- ✔ Fits in to corner of shed.
- ✔ Supplied with chain and padlock for securing cycle.



RING ANCHOR

IFY6.18

Very compact folding bolt down or wall mounted anchor.

This anchor when not in use is only 35mm in height from ground level making it ideal to drive or ride over.



OXFORD BRUTEFORCE

MINI ANCHOR

IFY8.03

Chain and padlock valuables to secure strong metal post.

- ✔ Sold Secure approved - Bicycle Silver.
- ✔ Hardened steel wall / ground anchor.
- ✔ Blue powder coated finish.
- ✔ Complete with two security fixings, steel ball inserts and FREE allen key.



BAT RIDGE ROOST



The Bat Ridge Roost provides a habitable roost space for small crevice-dwelling bat species found in the UK.

Designed in association with the Bat Conservation Trust as part of their Roost Partnership scheme the product is a self-contained, externally mounted unit which offers no means of access for the bats to enter the roof space or the property.

The Bat Ridge Roost is optimised to work in conjunction with the Manthorpe SmartVerge Polypropylene handed and ambidextrous dry verge systems (alternatively, could also be used with third party dry verge, traditional verge tiles or mortared in verge details).

The dual purpose product, also acts as a ridge end cap, providing a durable and protected covered finish for most styles of round ridge tiles and is located at the end of the ridge files on a gable end.

The Bat Ridge Roost is made up of two units

1. Mounting plate
2. Cover plate assembly (pre-assembled)

The cover plate assembly is a pre-assembled part which houses the bat habitat and insulation with three pre-fitted screws.



Terracotta



Black



Antique Red



Brown



Grey

- ✔ Fast and easy to install, dry-fix system
- ✔ Provides a protected roost for small bats to inhabit
- ✔ Roost is fully enclosed with no access to the property
- ✔ Part of the Bat Conservation Trust Roost Partnership scheme
- ✔ Creates a thermally stable environment for the bats to roost
- ✔ Designed for both round concrete and clay ridge tiles
- ✔ Provides a mechanically fixed, mortar-free solutions
- ✔ Protects the ridge end from exposure to the elements
- ✔ Suitable for new build and refurbishment details
- ✔ Can be installed on roof pitches between 15° and 55°
- ✔ Drains water away from the wall to prevent staining
- ✔ Manufactured from UV stabilised polypropylene

SWIFT BRICKS

SWIFT BRICK

As modern building practices have greatly improved the quality of new homes in the UK, some have actually suffered from the advances in building regulation.

Bird species such as swifts have occupied the cracks and crevices in our buildings for thousands of years, but the improved standard and style of modern construction has put their survival in our towns and cities at risk.

These popular birds come to the UK for three months during the summer to raise their young and can be seen on warm evenings giving spectacular displays. They eat large quantities of insect pests and spiders. They prefer nesting in small groups but the population has been dwindling for many years as suitable nest sites have become scarcer.

The Manthorpe Swift Brick has been developed in conjunction with major house builders and conservation experts to provide a safe, spacious and habitable area to allow swifts to nest within the well built construction of modern houses.

Available in the following colour variations:

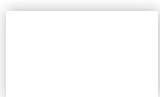

White



Red



Terracotta



Buff



Grey



Black

Takes the place of a single brick. The coloured face blends in to the surrounding bricks.

Built in cavity tray detail protects against water ingress.

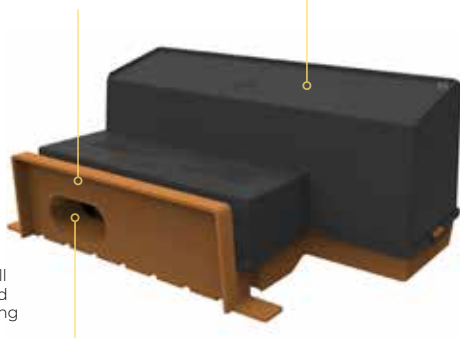

Easy to install
Can be fitted quickly during bricklaying.

29 x 65mm Opening Leading into a recessed entry tunnel.

Integral nest concave provides ideal starting point for nest building.

413cm² of floor area. Gives the maximum habitable living space within the wall construction

DUAL SWIFT BRICK

The compact design of the Dual Swift Brick allows it to work with narrower cavity wall details down to 50mm, making it ideal for modern timber frame constructions. Additionally, the twin brick profile can be easily retrofitted into existing walls with a minimum 50mm cavity.

- Takes the place of two bricks, with the coloured faces blending into the surrounding masonry
- Variant front slip option available for use with rendered walls, including entrance hole former
- Ambidextrous design can be installed with either left or right hand entrance
- Neat and simple to install, can be fitted quickly during the bricklaying or retrospectively afterwards
- The integral nest cup provides an ideal starting point for nest building
- 500cm² of floor area gives the maximum habitable living space within the wall construction

Takes the place of a single brick. The coloured face blends in to the surrounding bricks.

Built in cavity tray detail protects against water ingress.



Easy to install
Can be fitted quickly during bricklaying.

29 x 65mm Opening Leading into a recessed entry tunnel.

Integral nest concave Provides ideal starting point for nest building.

LOFT ACCESS HATCHES

Range of FD60 fire rated steel loft doors



EVERYTHING ON THIS PAGE IS MADE IN THE UK

DROP DOWN, FD60 FIRE RATED, STEEL LOFT ACCESS HATCH (BUDGET LOCK)

IFZ2.60 (SD)



- One hour fire rated
- Drop down hatch with continuous hinges
- Exceeds Part 'L' and NHBC requirement
- Air tested in UKAS accredited test facility
- Lightweight lid
- Powder-coated satin white RAL 9010
- U-value of 0.32 W/m²K.
- Structural opening 755mm x 555mm
- Clear opening 630mm x 520mm

DROP DOWN, FD60 FIRE RATED, STEEL LOFT ACCESS HATCH (EURO LOCK)

IFZ2.65 (SDL)



KEY LOCKABLE

- One hour fire rated
- Drop down hatch with continuous hinges
- Exceeds Part 'L' and NHBC requirement
- Air tested in UKAS accredited test facility
- Lightweight lid
- Powder-coated satin white RAL 9010
- U-value of 0.32 W/m²K.
- Structural opening 755mm x 555mm
- Clear opening 630mm x 520mm

PUSH UP, FD60 FIRE RATED, STEEL LOFT ACCESS HATCH

IFZ2.80 (SPI)



- One hour fire rated
- Simple push-up hatch
- Exceeds Part 'L' and NHBC requirement
- Air tested in UKAS accredited test facility
- GWP and ODP rated zero
- Powder-coated satin white RAL 9010
- U-value of 0.32 W/m²K.
- Structural opening 555mm x 555mm
- Clear opening 520mm x 520mm

FD60 FIRE RATED STEEL ACCESS PANELS

- Tested to BS476:pt 22
- Powder coated zintec steel
- White RAL9010 with 20% gloss
- Include budget lock



IFZ7.30 300x300mm
 IFZ7.35 350x350mm
 IFZ7.45 450x450mm
 IFZ7.55 550x550mm
 IFZ7.60 600x600mm

PLASTIC HANDI ACCESS PANELS

- Made from UV stable ABS
- Lightly textured surface
- Snap friction catch



IFZ6.10 100x150mm
 IFZ6.15 150x230mm
 IFZ6.20 200x200mm
 IFZ6.30 300x300mm
 IFZ6.35 350x350mm
 IFZ6.56 560x560mm

Sizes above are structural opening sizes. For overall frame size, add 50mm to each measurement. For clear opening size excluding door thickness, when in open position take 36mm off one size and 63mm off the other - this excludes the diagonal corners.

WATERPROOF PLASTIC CIRCULAR ACCESS PANEL

- Waterproof 'O' ring design
- White polypropylene semi-gloss finish
- 6 concealed fixings*
- Twist action open/close
- Fine thread for a high compression
- Easy to install



*200mm has visible fixings

IFZ8.10 300x300mm
 IFZ8.12 350x350mm
 IFZ8.15 450x450mm
 IFZ8.20 550x550mm

NON FIRE RATED LOFT ACCESS HATCHES

AT35 AIRTIGHT PART 'L' DROP DOWN
IFZ1.45 (SD)



- Steel frame
- Drop down hatch with inset hinges
- Exceeds Part 'L' and NHBC requirement
- Air tested in UKAS accredited test facility to 50Pa
- Spring-loaded catch for a high compression seal
- Powder-coated satin white RAL 9010
- U-value of 0.35 W/m²K.

Structural Opening = 640 x 560mm
Clear Opening = 538 x 520mm

PD35/PD25/PDI5 CONTEMPORARY PART 'L' DROP DOWN
IFZ1.35 (SDL)



KEY LOCKABLE

- Flush fitting to ceiling
- High impact white styrenic plastic
- Drop down hatch with continuous hinges
- Concealed seals
- Exceeds Part 'L' and NHBC requirement
- Air tested in UKAS accredited test facility
- GWP and ODP rated zero
- UV stable smooth satin finish
- U-value of 0.35 W/m²K.

Structural Opening = 755 x 755mm
Clear Opening = 630 x 520mm

DROP DOWN LOFT DOOR
IFZ1.20



- The door and frame are fully draught sealed
- Seals are supported by multiple perimeter catches
- Sliding door mechanism is operated from a single point
- Innovative hinge detail is hidden when the door is locked
- The design allows for the door to be fully removed in seconds
- All hinge, catch and fixing geometry outside of the door seals
- Hinge pivot positioned to provide largest accessible opening
- Frame screws up into ceiling timbers for simpler installation
- Insulated area on the back of the door is fully maximised U-value 0.35 W/m²K.

Structural Opening = 726 x 560mm
Clear Opening = 715 x 545mm

ALUMINIUM LOFT LADDERS

- Available in 2 and 3 sections
- Easy to install
- Safe and comfortable flat rungs
- High quality aluminium construction
- Complete with handrail, trap door hinges, auto-latch pole and hook
- Weight limit: 100kg
- Kitemarked to BS7553 Class G (General Use)
- Does not include loft access door (sold separately, see pages 2, 3 & 4) Drop down only.



Max Floor To Floor Height	Mini Loft Clearance	Min Loft Opening
3.0m	1050mm	432x508mm

TECHNICAL INFORMATION - MATERIALS:

STILES AND TREADS - Extruded Aluminium Alloy

HANDRAILS - Aluminium Alloy Tube

OPERATING POLE - Aluminium Alloy Tube with plastic lug to operate door catch

OTHER FITTINGS - Steel, zinc alloy and plastic

DUTY RATING:

User and items must not exceed the maximum safe working load of 100kg (15.7 stones)

IFZ3.02 2 SECTIONS

IFZ3.03 3 SECTIONS

VENTILATION PRODUCTS

A range of ventilation products to suit the builder's needs



HOODED LOUVRE
IFS12.12

Made from high-quality 1.5mm material and suitable for exterior doors and walls. Special sizes are available. Available finishes include chrome plating, polished brass, satin brass, IBMA (Imitation Bronze Metal Antique), satin stainless steel, polished stainless steel, satin chrome plate, satin anodised aluminium, polished nickel and satin nickel.



PLASTIC LOUVRED
VENTILATOR

IFS12.26

- Plastic Louvre grille with flyscreen
- Low-profile fixed open louvres
- For internal and external use
- UV stable plastic

Do not use to provide ventilation to boilers, stoves and fires

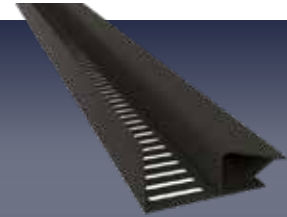

SOFFIT STRIP

IFZ1.07

Continuous Soffit Ventilators are designed for use with a traditional fascia board to provide roof ventilation. Ventilation solutions available various soffit details.

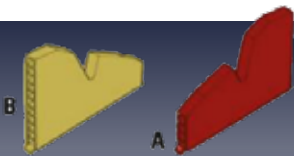

DUAL WEEP VENT

IFZ14.14

These are designed to meet NHBC guidance note. Weep holes are recommended every 450mm maximum with at least 2 per opening above windows and doors. The dual purpose of these vents is:

- A) Concealed weep
- B) Exposed weep

Available in Terracotta, Brown, Black, Buff Grey, Clear White.

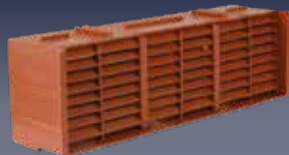

AIR BRICK

IFZ1.10

These interlockable air bricks have been designed for a wide range of ventilation applications. The louvres act as excellent barriers against driving rain and a two-step integral water barrier has also been incorporated for added peace of mind.

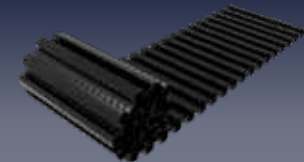

EAVES PANEL VENT

IFZ1.07

The Continuous Roll Panel Vents are designed to maintain a flow of air to the roof space from outside, thereby allowing the escape of built-up moisture.

A wider range of products is available - please ask our Sales Office for further details.

SEALANTS, ADHESIVES AND FILLERS

Firth Doors & Hardware Ltd have teamed up with Everbuild Building Products Ltd, the UK's leading name in sealants, adhesives and building chemicals, to offer a comprehensive range of products selected especially for the housebuilder.

GENERAL PURPOSE SILICONE

General Purpose Silicone is a high modulus silicone sealant that adheres to most smooth and non-porous materials. Contains an anti-fungal compound to prevent mould growth in areas of high humidity. Forms a permanently flexible rubber seal. Available in black, brown, grey, clear and white. Silicones in other colours can be ordered as specials.

IFS19.01

C3 cartridge / 25 per box



INSTANT NAILS

Instant Nails is a high-strength solvent free grip filling multi use adhesive that provides a quick grab and replaces mechanical fixings in many home improvement applications. Dries white and may be overpainted if required.

IFS19.02

C3 cartridge / 25 per box



SEALANTS, ADHESIVES AND FILLERS

WOOD ADHESIVE

D4 Wood adhesive is a solvent-free industrial grade D4 wood adhesive based upon the latest hybrid resin technology. Can be used internally or externally. Gives a high strength, totally waterproof, impact and temperature resistant bond that is usually stronger than the wood itself. Ideal for wood working, joinery and commercial assembly work.

IFS19.03 1000ml bottle / 12 per box



DECORATOR'S CAULK

125 One hour Caulk is a fast-drying flexible decorator's filler and sealant that remains permanently flexible. Can be overpainted with most paint types or covered over with wallpaper - no sanding down required.

IFS19.04 C3 Cartridge / 12 per box



EXPANDING FOAM

Gun Grade Expanding Foam is a quick setting polyurethane based foam which expands greatly on application and yields up to 50 times original can contents

IFS19.13 500ml cartridge / 12 per box
(also available in 750ml)

IFS19.14 Gun Grade



STIXALLO SEALANT

The ultimate combined building adhesive and sealant. This product sticks virtually anything to everything in virtually any weather conditions giving a powerful bond with excellent watertightness. Solvent-free and can be painted over if required.

IFS19.20 C3 cartridge / 25 per box



PINKGRIP

Pinkgrip will stick just about anything on a building site. Its amazing grabbing strength not only removes the need for pinning but eliminates the need for double stick methods. Prevents slipping and slumping.

IFS19.21 350ml tube/12 per box



FIRE MATE SEALANT

Fire Mate is an intumescent acrylic sealant that swells when exposed to temperatures in excess of 125°C to prevent the passage of fire and smoke and has a fire rating of up to 5 hours in certain joint configurations.

IFS19.08 C3 cartridge / 25 per box



MULTI-USE WONDER WIPES

The first choice of the nation's builders and tradesmen. Specially formulated to clean hands, tools and surfaces from wet and semi-cured paint, sealant, adhesive, bitumen, expanding foam, oil, grease and even silicone. Now contains a powerful anti-bacterial additive

IFS19.22 C3 cartridge / 25 per box



METAL FOAM GUNS (MEDIUM AND HEAVY DUTY)

P45 (Medium Duty) and P65 (Heavy Duty) foam guns give the user more control to apply the foam precisely in hard to reach places, therefore saving unnecessary wastage. For professional use.

IFS19.17

Sold individually:

M = Medium Duty, P = Professional Heavy Duty



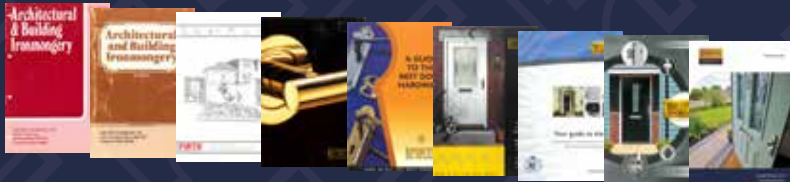

Originally selling from generic industry catalogues, from 1991 there have been a range of brochures covering product ranges from hardware to doors and from radiators to bird boxes.

The company logo has changed over the years going through various incarnations before evolving into the familiar gold/black logo of today.



2006

ISO9000 REGISTERED COMPANY

2006 After over two decades of delivering quality service, the company achieves **ISO 9000 certification**, ensuring that its management systems and processes meet the highest standards for customer assurance.



2013

PVC FRAMES INTRODUCED

Further investment in **PVC frame production machinery** enables the company to expand its **external doorset designs**, including in-house manufactured frames with fanlights and sidelights.



2015

PRODUCT RANGES COVERED

To better showcase its expanding product range, the company publishes **five new brochures** covering External Doors, Internal Doors, Hardware, Associated Building Products, and Environmental Products. Additionally, **three new Directors** are appointed to the board, all having progressed through the company's ranks.



2022

RECORD TURNOVER AHEAD OF ANNIVERSARY YEAR

Despite the challenges of Covid years, company rebounds with record **£16M+ turnover**. Continued growth driven by **machinery investment** and upgraded sales order software, reinforcing focus on **product innovation** and **customer service**.



2023

£300K INVESTMENT

Spurred on by increasing customer demand the company made a **£300k investment** in a **second Italian CNC machine** to **increase external door machining capacity by 50%**.

2009

ECO FRIENDLY

A new product range is launched to support the **Code for Sustainable Homes**, providing housebuilders with eco-friendly solutions such as compost bins, recycling bins, water butts, clothes airers, cycle storage, bird and bat boxes, and fold-up bikes. The company also achieves **ISO 14000 certification** for environmental management.

2011

SECURED BY DESIGN

The external doorset range gains **Secured by Design** approval, meeting police-endorsed security standards. Investment in **new Italian CNC machinery** boosts production capacity, keeping up with growing demand for **GRP-faced doors** over steel alternatives.

2018

DOORKIT PRODUCTION GROWS

With annual demand reaching **50,000 internal doorkits**, the company invests in additional **CNC machines** and expands its production team. The **Quicksemble Doorkit system** gains widespread recognition in the housebuilding sector.

2019

CNC INCREASES OUTPUT

2019 A state of the art **Italian £250,000 CNC machine** is commissioned to expand **external composite door production further**, allowing the company to grow its customer portfolio.

2024

CHANGE OF OWNERSHIP

Mr & Mrs Firth retire, marking a **key milestone**. Ownership passes to the remaining **four directors** who have been instrumental in shaping the business in recent years, ensuring a **seamless transition** and **continued success** while carrying forward the vision with renewed commitment and strategic direction.



ABLP Hestia Ltd

Lady Ann House,
Shaw Cross Business Park,
Dewsbury, West Yorkshire,
WF12 7RD

01924 438 112



sales@firthdoors.co.uk

www.firthdoors.co.uk



PRODUCT GUIDE

03/26